

---

# Constantine & Rome

R. ROSS HOLLOWAY

Yale University Press *New Haven and London*

CC

Con  
role  
of t  
and  
and  
on  
tin  
des  
an

H  
C  
C  
p  
th  
m  
ti  
P  
r  
t  
i

Copyright © 2004 by Yale University. All rights reserved. This book may not be reproduced, in whole or in part, including illustrations, in any form (beyond that copying permitted by Sections 107 and 108 of the U.S. Copyright Law and except by reviewers for the public press), without written permission from the publishers.

Designed by Rebecca Gibb. Set in Adobe Minion by Duke & Company, Devon, Pennsylvania. Printed in the United States of America by Sheridan Books, Ann Arbor, Michigan.

Library of Congress Cataloging-in-Publication Data

Holloway, R. Ross, 1934–

Constantine and Rome / R. Ross Holloway.

p. cm.

Includes bibliographical references and index.

ISBN 0-300-10043-4 (alk. paper)

1. Architecture, Early Christian—Italy—Rome. 2. Architecture—Italy—Rome. 3. Constantine I, Emperor of Rome, d. 337—Art patronage. 4. Christianity and art—Italy—Rome. 5. Rome (Italy)—Buildings, structures, etc. I. Title.

NA5620.A1H65 2004

722'.7—dc22

2003018712

A catalogue record for this book is available from the British Library.

The paper in this book meets the guidelines for permanence and durability of the Committee on Production Guidelines for Book Longevity of the Council on Library Resources.

10 9 8 7 6 5 4 3 2 1

# Contents

PREFACE ix

LIST OF ABBREVIATIONS xiii

- I Constantine and the Christians 1
- II The Arches 19
- III Basilicas, Baptistry, and Burial 57
- IV The Tomb of St. Peter 120

NOTES 157

GLOSSARY 177

BIBLIOGRAPHY 179

INDEX 187

### III Basilicas, Baptistry, and Burial

#### *The First Christian Churches of Rome and the Birth of the Christian Basilica*

The basilica of S. Giovanni in Laterano stands on the highest point of the Caelian hill just inside the Aurelian walls (fig. 3.1). There are no steep approaches, only a gradual ascent from the area of the Colosseum to the point where the Caelian ridge meets the Esquiline plateau. The eighteenth-century façade of S. Giovanni magnifies the height of the church through five grand arches carried from the ground level to the cornice far above. Along the top of the façade there is a glorious epiphany in which a company of saints gesticulates fervently around the figure of Christ Himself beckoning from a raised podium. Because of the open space fronting on the church the building retains something of its appearance before the modern expansion of Rome after 1870 when it was an isolated urban monument amid the cloisters, villas, and gardens surrounding it. The same held true for the early Christian basilica at a time when the area was also one of gardens and great properties.

The interior of the church has no traces of its early Christian appearance. The nave, flanked by gigantic figures of saints to left and right, was designed by Francesco Borromini in the seventeenth century. The crossing is dominated by the tabernacle over the papal altar, a Gothic structure of the fourteenth century. The frescoes of the transept are important works of the Mannerist period in the sixteenth century.

This is the seat of the bishop of Rome and has been ever since the church was built by the emperor Constantine beginning possibly within a month of his victory at the battle of the Mulvian Bridge and dedicated several years later.<sup>1</sup> The work required first clearing the ground,



Fig. 3.1 S. Giovanni in Laterano, façade. Photo Fototeca Unione Neg. 1627. Copyright.

which had been occupied by the barracks of the *Equites Singulares*, a corps faithful to Maxentius that was suppressed by the new emperor.

The corner of Rome where the basilica arose adjoined the Sessorian Palace, where Constantine made his Roman residence, which he ceded to the dowager Empress Helena after he decided to transfer the capital of the empire to Constantinople in 326.<sup>2</sup> The bishop of Rome and his church were very much guests and the emperor the host. Constantine intended to keep this newly favored cult and its leader firmly under the imperial thumb.<sup>3</sup>

The church that was erected, the *Basilica Constantiniana*, is vivid evidence of the size of the Christian community at Rome at the end of the Great Persecution (fig. 3.2). No small band of faithful could have prompted the building of a giant cathedral. The church was 333½ Roman feet (a Roman foot equals 29.6 cm, shorter than the English foot by less than one cm) in length and 180 Roman feet wide (including the thickness of the outer walls). The Constantinian building is known principally from its foundations, exposed in 1934–38, and Borromini's plan of 1646.<sup>4</sup> It was a large rectangle divided into a wide nave and four side aisles, two on each side. Each side aisle was 30 Roman feet in width, and the nave was equal to two side aisles. However, a small apse projected at the west end (radius 30 Roman feet). The church also had a transept, although a modest one created by two small projections at the western

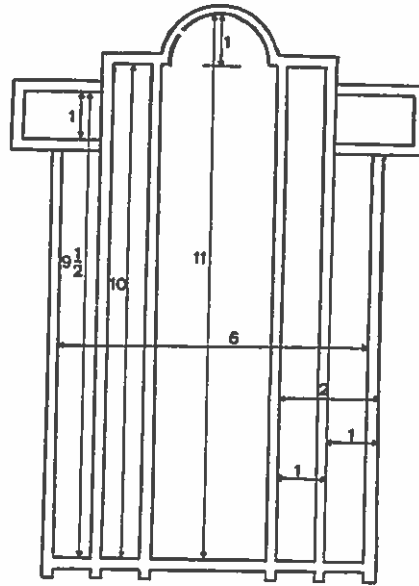

Fig. 3.2 S. Giovanni in Laterano, plan. After CBCR.

end of the nave arranged so that they cut across the outer aisles of the church but did not interfere with the inner ones. There were twenty or possibly twenty-one columns on each side of the nave. The twenty-four columns of *verde antico* marble employed to flank the niches of the huge saints of the present nave originally belonged to the colonnades between the side aisles north and south. The capitals of the nave colonnade, obviously taken from various earlier buildings, are documented in seventeenth-century painting as well as by Borromini's survey drawings, which show that the columns supported arches.<sup>5</sup> The brickwork of these continued into the walls above.<sup>6</sup>

What we can thus recapture of this large hall, with double side aisles and a small apse, is a ghost of the first great church of Christendom (fig. 3.3). But some idea of the sumptuousness of its original state is given by the list of furnishings that were provided by the founder.<sup>7</sup>

A silver paten weighing twenty pounds.

Two silver scyphi each weighing ten pounds.

A gold chalice weighing two pounds.

Five service chalices each weighing two pounds.

Two silver amae each weighing eight pounds.<sup>8</sup>

A silver chrisms-paten, inlaid with gold, weighing five pounds.

Ten crown lights each weighing eight pounds.

Twenty bronze lights each weighing ten pounds.

Twelve bronze candlestick chandeliers each weighing thirty pounds.

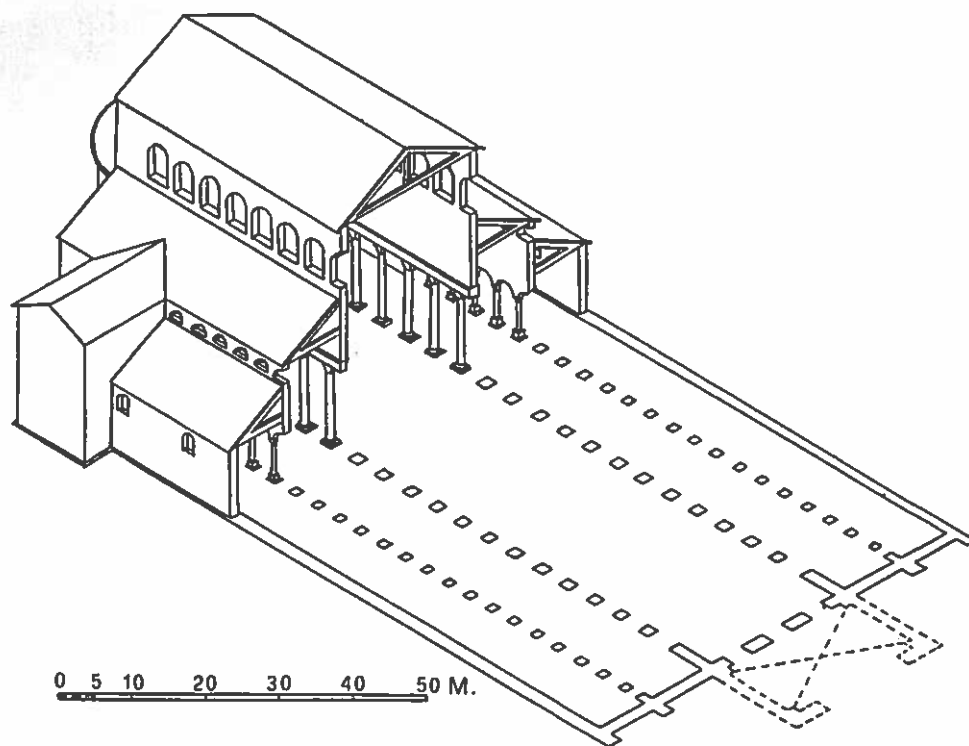

Fig. 3.3 S. Giovanni in Laterano. Isometric reconstruction. After CBCR.

The total revenue of the estates assigned to the church gave it an annual income of 413 gold solidi. Fragments of yellow marble found in 1934 and hooks for the attachment of revetments hint at the decoration of the interior. And, if we can judge from the decoration of the original San Pietro, the bishop's seat in the apse was emphasized by the gilding of its half dome. Irrevocably lost are the hangings, paintings, and mosaic work that we can imagine beautified the church in its original state. And missing are the crowds that were expected to fill the vast hall. For this building, as for so many early Christian churches, there is no evidence for decoration of the exterior. The simple brick of the Christian churches, although perfectly in keeping with Roman utilitarian architecture, was a jarring contrast to the exteriors of pagan temples.

The church existed for the celebration of the Eucharist. Baptism was given by the bishop in the adjoining baptistry (see below). But the ceremonies that marked these and other occasions are most imperfectly known.<sup>9</sup> During the excavations of the 1930s two parallel rows of sockets came to light in the nave.<sup>10</sup> These seem to have been intended to support the posts for barriers at either side of the processional corridor by which the bishop and clergy entered the church in state.

By day the church would have been awash with light. The windows in the clearstory of the nave were blocked up in the seventeenth century, but originally the church would have been lit from this source. The aisles, too, seem to have been provided with smaller, semicircular

or arched windows both in the outer wall and in a clearstory above the colonnade where the two aisles meet. The apse apparently had windows, and there would have been others, no doubt sizable ones, in the façade.<sup>11</sup>

To recapture the atmosphere of this and other early Christian churches in Rome one must go to the church of Santa Sabina on the Aventine (figs. 3.4, 3.5). The church is fifth century, and it has been restored to much of its original state. There are a nave, side aisles, and an apse. The building was entered directly from the west. The central doors still have the famous set of carved cypress wood panels contemporary with the building of the church. The interior is full of light. It enters through the three high arched windows of the apse, through the clearstory windows, and through five large arched windows over the doorways. This is the atmosphere that must have prevailed in the large basilicas by day. No Romanesque darkness, no claustrophobic, underground setting like the chapels of Mithras, but the light of the world shining on the gathering of the faithful. Those who have attended divine service in a Christopher Wren church, or any of the grand progeny of the master across the sea in North America, will appreciate the psychological effect of light radiating through the congregation at prayer.

And so one must imagine San Giovanni, but with a sea of Roman Christians joyful and triumphant. Three thousand could be accommodated within its walls. The communicants would fill the nave, the catechumens, as yet unbaptized and thus inferior in status, would gather in the aisles (this point will be argued further below). The clergy, in no small numbers, surrounded the bishop on his throne. Constantine and his architects did not overestimate the size of the gatherings, as is shown by the need that was felt to create an artificial corridor through the throng by means of the sockets and posts mentioned above, just as barriers create a passageway for the pope today when he enters San Giovanni or San Pietro on the great feast days. No one who has not experienced the mystery of the consecration as part of such a vast congregation can appreciate the power of the eucharistic service in San Giovanni of Constantine's day. In the evening and at night the effect of Constantine's lamps and candles, gold and polished bronze, must also be imagined in the setting of rich furnishings and intense piety they illuminated.

It is clear that a large hall such as the new church of the bishop of Rome was a building in the tradition of Roman indoor assembly halls, whether the public basilicas of the fora or the auditoria of the mansion and palace. The question surrounding the appearance of the basilical church is thus not one of building experience and scale, but whether conscious tradition from such earlier secular buildings was felt by Constantine's generation when they confronted the new Christian basilicas. To pursue this question I want to consider how Christians not blessed by imperial patronage and the requirements of an episcopal seat, or even the imperial family when adapting part of a palace to Christian worship, met their needs.

We cannot achieve this end by turning to Christian churches of the third century. Aside from the famous house church at Dura Europos, a Mesopotamian outpost of the empire in the east, there is scant evidence of where the Christians met and prayed.<sup>12</sup> We do, however,

old  
nts  
igi-  
ne.  
ied  
rast  
ra-  
ing  
les.  
op  
ca-  
of  
for  
he  
of  
ive  
lar



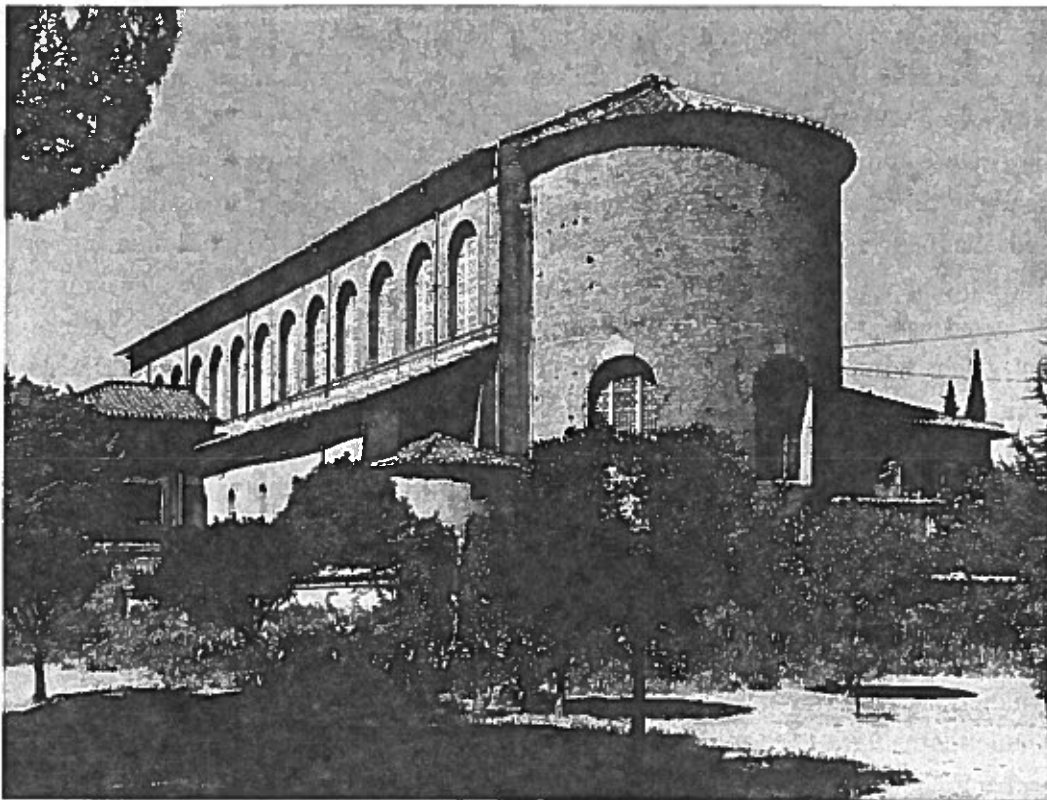

Fig. 3.4 S. Sabina. Photo Bartl, DAI Rome, Inst. Neg. 61.2507. Copyright Deutsches Archäologisches Institut.

have good documentation in Rome for the adaptation of Christian worship to the city in various churches of Constantinian and later date. And these buildings repeat, I believe, the expedients of earlier generations of Christians.

The best-known house church (*domus ecclesia*) of Rome is to be found underneath the church of SS. Giovanni e Paolo (fig. 3.6). SS. Giovanni e Paolo, built in the early fifth century, is also on the Caelian hill, but it is to be found at its western end, toward the center of the city, rather than at the eastern extremity, where S. Giovanni in Laterano was built. The church is oriented east–west. Its southern flank (and so the flank of one of the long sides) borders the ancient Clivus Scauri, a street running steeply downhill in the direction of the Palatine and the Circus Maximus. From this little piece of the distant past one gains a vivid idea of the appearance of many other streets in the populous quarters of Rome. The street was narrow. The brick apartment houses were multistoried. Behind a portico running partway down the street shops opened directly on the exterior. Brick arches thrown across the street supported the houses on either side. Those familiar with the old quarters of Naples will have no difficulty imagining the bustle and noise of the street in the fourth century. The artisans of the shops must have daily practiced their trades under the porticoes, mending pots, making shoes, and beating out brass. The housewives, then as now, would have been at the windows of the upper

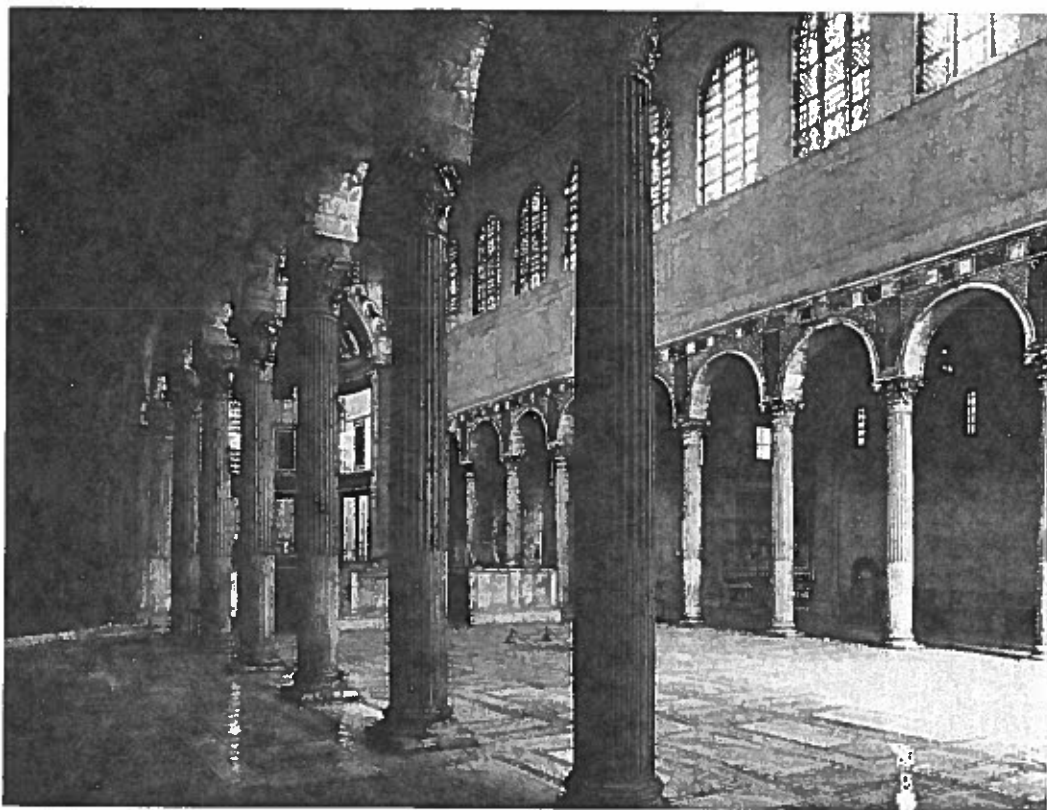

Fig. 3.5 S. Sabina, interior. Photo Bartl, DAI Rome, Inst. Neg. 61.2514. Copyright Deutsches Archäologisches Institut.

stories to lower a basket to passing peddlers with all kinds of wares and all kinds of food. They gossiped across the alley, and in the midst of conversation hailed their children with the shrill voices that Italian women still have at their command. Only the smell is beyond our ability to imagine.

In the second century, there were at least four houses under and around the area now occupied by the church (fig. 3.7). The façades along the Clivus Scauri belong to two Roman apartment blocks. The eastern one (uphill) is essentially unexcavated. Its brickwork places it in the third century. The ground floor of its neighbor downhill was a building with a series of shops on the ground floor (each with the characteristic Roman plan of the shop proper and another room behind). The brickwork is of the mid to later second century. The eastern part of the building was rebuilt in the third century. From the façade along the Clivus Scauri and the windows opening on it one can form an idea of the interior of the second-floor apartments. It has been suggested that the uphill section of the building was renovated at some time to create a single large room divided by a set of arches in place of the apartments on its second floor.<sup>13</sup>

Behind the two apartment houses facing on the Clivus Scauri there was an alley and on



Fig. 3.6 The Clivus Scaurus and SS. Giovanni e Paolo. Photo Fototeca Unione Neg. 645. Copyright.

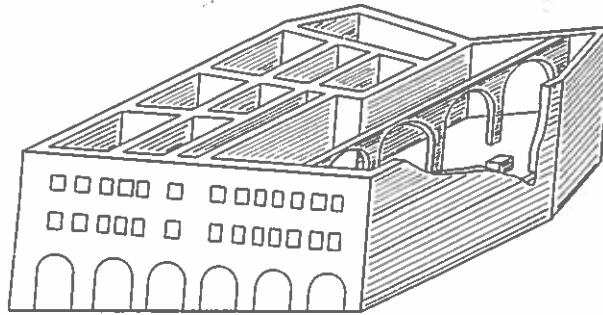

Fig. 3.7 SS. Giovanni e Paolo. Tentative reconstruction of the early Christian phase. After CBCR.

its opposite side another building, which Richard Krautheimer interprets as follows: "It appears to have been either a private residence with a thermal establishment on the lower floor, or a thermal establishment with apartments on the upper stories."<sup>14</sup> The marine fresco in a small nymphaeum with a fountain found in this building shows that its occupants had some pretensions, as do the other pagan frescoes of the building (fig. 3.8). At some time the courtyard in the eastern part of the house was vaulted over, creating a large room above.

The first evidence of Christians on the spot comes from the ground floor of the downhill building on the Clivus Scaurus. In the back room of the third shop (counting from the west) there are frescoes and among them a figure with arms uplifted in prayer (an *orans*). With the *orans* figure there is a philosopher figure (but in this context possibly an apostle), then a



Fig. 3.8 SS. Giovanni e Paolo. Fresco. Photo Hutzler, DAI Rome, Inst. Neg. 65.2035. Copyright Deutsches Archäologisches Institut.

pair of seahorses (hippocamps) and goats.<sup>15</sup> The identification of these isolated figures as Christian, however, is far from certain. The decoration of this and the adjoining room, in which there is an elegant series of male figures alternating with birds, peacocks and ducks among them, the whole surmounted in the ceiling vault with a vine motif with cupids gathering the grapes, is of high quality (fig. 3.9). It may be dated to the opening of the fourth century and, together with the decorations of the nymphaeum in the courtyard, suggests that this was a period in which the entire complex on both sides of the alley was a residence of some style and the shops under the arches were suppressed.<sup>16</sup>

The alley behind the structures with their façades on the Clivus Scaurus had at some time been vaulted over, creating a cryptoporticus. A stairway was subsequently built against the rear wall of the same structures. The stairs are judged to have been built in the first half of the fourth century.<sup>17</sup> This stair led to a landing on the level of a window (or *fenestrella*) which opened onto a shaft rising from the ground level below (figs. 3.10, 3.11). This arrangement, constituting a confessional for the adoration of the relics housed at the bottom of the shaft, is described by Krautheimer as follows:

t ap-  
loor,  
in a  
ome  
yard  
  
own-  
the  
With  
ten a



Fig. 3.9 SS. Giovanni e Paolo. Fresco. Photo Hultze, DAI Rome, Inst. Neg. 65.2048. Copyright Deutsches Archäologisches Institut.

The upper part of the confessional, as it rises now at the level of the landing, that is at the mezzanine level of the apartment house, presents itself as a small square box-like construction. Its front wall, facing the landing, is pierced by a small window, a "fenestrella," and so are its side walls. The "fenestrella" in its front wall is surrounded by a fresco which, below the "fenestrella," shows a male figure, possibly Christ, adored by a man and a woman in proskynesis (prostrate), and at the sides, Saint Peter and Saint Paul. On the left projecting wall of the landing appears the martyrdom of two Saints, possibly Saints John and Paul, on the right wall the martyrdom of three others, two men and one woman. The top of the confessional was later cut off by the pavement of the basilica. Yet, certainly its ceiling originally projected beyond the level of the mezzanine floor into the second floor of the house. On this level, near the first right-hand pier in the present church, the site of the confessional is marked by a marble slab indicating the place where an altar stood up to 1573. It is likely that there was always an altar at this place; remnants of one dating possibly from the V or VI century were found in the excavations. Nothing precludes the existence of an altar on this spot from the time the confessional was built.<sup>18</sup>

The space at the bottom of the shaft has a monochrome mosaic floor. Below it, two cavities were excavated in 1912. They could have been tombs, and they have been interpreted as those of Saints John and Paul, who, according to tradition, were put to death and then buried "in their palace" on the Caelian hill in 365.<sup>19</sup>

This reading of the evidence has been disputed by Beat Brenk. This author holds that the fenestrella itself held a repository for whatever relics were the subject of Christian veneration in the house.<sup>20</sup> In his view this was a private chapel of a Christianized family in the fourth century and remained so until the creation of the Titulus Pammachii, the first phase of the present church of SS. Giovanni e Paolo, during the fifth century.

Returning to the large room on the second floor of the uphill section of the building fronting on the Clivus Scauri, we find what Krautheimer suggested was the Christian meeting room. It was reached by the staircase from the cryptoporticus and was adjacent to the confessional. Although the identification of this room as a Christian hall is hypothetical, there was surely a Christian presence in the building.<sup>21</sup>

SS. Giovanni e Paolo illustrates how the Christians could find room for their services and made a space for their relics in the ordinary houses of the city. Any important house or palace, however, had halls that were easily adapted to a new purpose. This is the case at S. Croce in Gerusalemme, also located behind the Aurelian walls a short walk from S. Giovanni. This church adapted a hall in the Sessorian Palace, which was the residence of the empress Helena. And it was to this church that the empress brought a relic of the cross of the crucifixion that is still preserved there today.

The piety of Constantine's mother and her devotion to the shrines of the Holy Land were famous. It is more difficult to know whether her recovery of the true cross and her bringing a relic of the cross to Rome is fact or fiction, but the burden of the evidence is against accepting it.<sup>22</sup> Whether the cross was even known during her lifetime (she died before 328, the date is variously fixed) is a matter of dispute. Eusebius, who would certainly not have let such a wonderful discovery go unnoticed, says nothing about it, although St. Cyril, bishop of Jerusalem from 348 on, is loud in its praises.<sup>23</sup> This problem bears on the date of S. Croce. Although the church is attributed to Constantine by the *Liber Pontificalis*, initially a simple list of the bishops of Rome expanded in the sixth century and later into biographies of each, this information could be a conflation of the great emperor's name with a building sponsored by one of his sons.<sup>24</sup>

The original hall, the masonry of which dates to the third century, measured 133 Roman feet in length and 84 Roman feet in width (fig. 3.12).<sup>25</sup> The height of the room is 75 Roman feet, almost the same as the interior width of 74 Roman feet. In the long walls there are five arched openings and five rectangular windows above them. On the north side there is a cornice between these apertures. On the south side there is no cornice but there is a setback below the upper windows. The shorter walls also seem to have had five windows each (this arrangement must be assumed for the east end, where the present apse is located). There were secondary

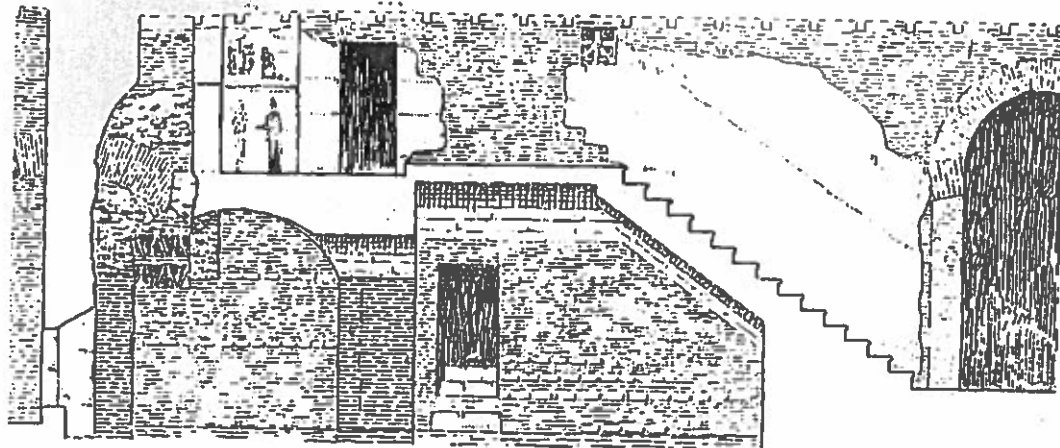

Fig. 3.10 SS. Giovanni e Paolo. Section through the courtyard and staircase adjoining it. After Colini, *Storia e Topografia del Celio nell' Antichità*.



Fig. 3.11 SS. Giovanni e Paolo. Fenestrella of the confessional and frescoes. Photo Hutzle, DAI Rome, Inst. Neg. 65.2038. Copyright Deutsches Archäologisches Institut.

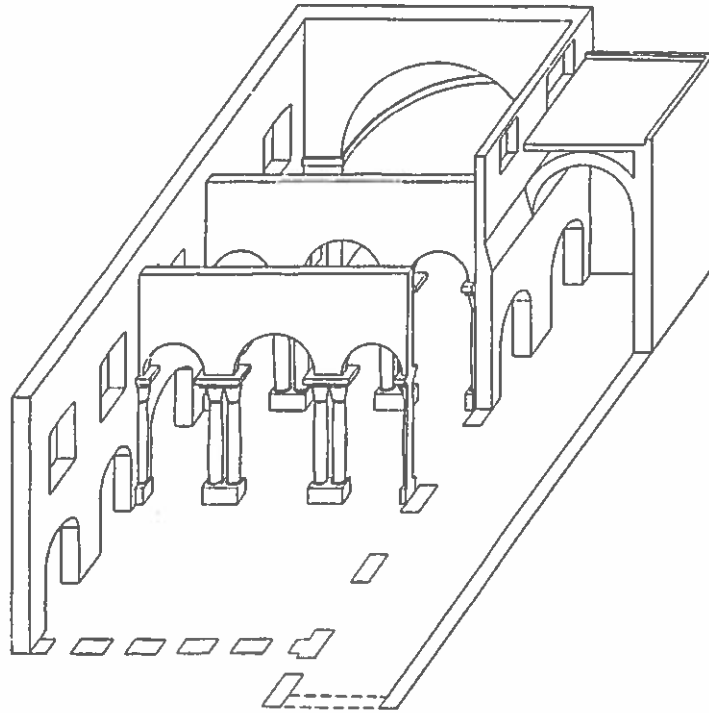

Fig. 3.12 S. Croce in Gerusalemme. Reconstruction of the hall converted into a church. After CBCR.

structures attached to the east side and the south side. Also part of this structure was a small room beyond the southeast corner which is the present Chapel of St. Helena.

The transformation of the hall into a Christian church was easily accomplished. An apse was installed at the east end (and most of the earlier wall across the east end was removed in the process). The entrance was now shifted to the west. The secondary structure on the south side was maintained. It became an aisle and communicated with the nave through the original arches in the south wall. On the north the arches and windows remained open, giving onto the outside. At some point two transverse walls were built across the nave to carry triple-arched openings. It is noteworthy that the south aisle of the church was matched not by another aisle but by an arcade leading to the outside. This arrangement occurs in other churches and, as we shall see below, is related to the treatment of catechumens in the early Church.

An almost identical transformation occurred in the case of Santa Susanna, a church justly famous for its early baroque façade by Carlo Maderno (fig. 3.13). Santa Susanna is situated along the ancient road, now the Via XX Settembre, that runs along the top of the Quirinal ridge to the Porta Nomentana. It preserves the two side walls of a hall that was evidently part of a magnificent domus located at the edge of the ring of gardens and villas that surrounded the populous quarters of Rome. Glimpses of the eastern side wall can be obtained from the outside of the building. This long wall of the hall was originally pierced by three tiers of arched



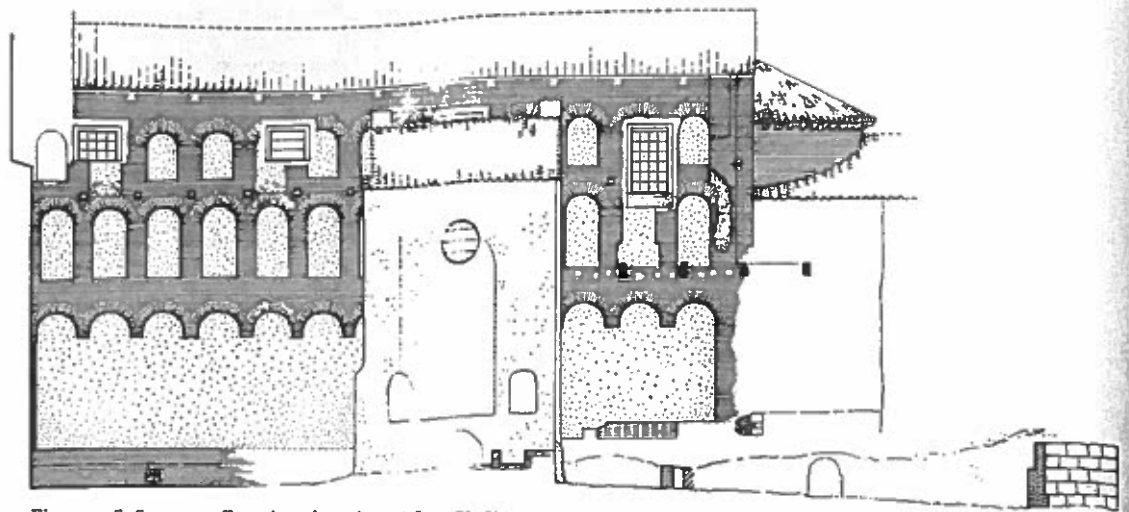

Fig. 3.13 S. Susanna. Exterior elevation. After CBCR.

windows. The hall was built in the fourth century, and when it was transformed into a church an apse was added at one end and side aisles with galleries above were installed along the long walls. The church was 120 Roman feet in length, and the nave 45 Roman feet wide. The height of the clearstory walls was 55 Roman feet.

In some cases existing halls were taken over with practically no modification. Such may be the case of Santa Balbina, which is located in a modern Roman green zone within a stone's throw of the Baths of Caracalla. Santa Balbina is a large hall, 82 Roman feet long and 50 Roman feet broad. It has an apse but no side aisles. Instead there is a series of niches in the side walls. The masonry of the building dates it to the fourth century, but its conversion to ecclesiastical use is surely much later. The theory of a secular origin of this church and a late date for its transformation is supported by the case of S. Andrea in Catabarbara, the fourth-century Basilica of Junius Bassus. This building, which stood in the populous part of the Esquiline, did not become a church until the end of the fifth century under Pope Simplicius.<sup>26</sup> It has seemed natural to attribute it to the Junius Bassus who died in 359 at the age of forty-two and whose sarcophagus in the Vatican is one of the major monuments of early Christian art.<sup>27</sup> An inscription copied before the building was torn down, partly in the eighteenth century and finally in 1932, gives the name of the builder Junius Bassus *consul ordinarius*.<sup>28</sup> Two consuls of that name are known, one in 317, the other, apparently the father of the Junius Bassus of the sarcophagus, in 331. This basilica, known from Renaissance drawings, was a simple hall fronted by a porch. There was an apse, and the interior was lighted by three large windows on the sides and three more over the porch. The interior was covered with elaborate decoration in colored marble (*opus sectile*), of which some pieces are preserved.

In another of the densely built-up quarters of ancient Rome, the valley between the Esquiline and the Caelian, which runs from the Colosseum in the general direction of S. Croce in

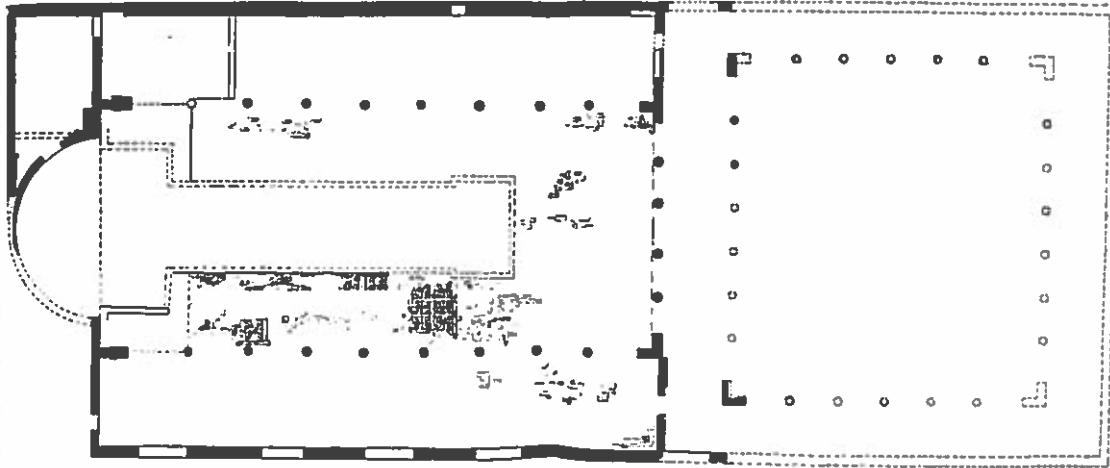

Fig. 3.14 S. Clemente. Plan. After CBCR.

Gerusalemme, we find the church of the SS. Quattro Coronati. The church is of Carolingian date (ninth century), but it too incorporates a large hall of the fourth century, originally terminating in an apse.<sup>29</sup>

Located nearby there is a church well known to all enthusiasts of subterranean Rome, S. Clemente, memorable not least because the lowest level below the church contains the remains of a mithraeum. The church belongs to the end of the fourth century (fig. 3.14).<sup>30</sup> However, it is certain that there was a house church (*titulus*) on the spot before.<sup>31</sup> The early basilica (known in detail from the excavations) was created from a Roman house which had a hall with wide openings on its sides. The openings were left in the south wall of the basilica. The church was a simple wide hall with two aisles and ending in a shallow apse. It was entered directly from an atrium through a wide opening with four columns. The date of the basilica is the later fourth century.

S. Crisogono, built as a church and as early or earlier than S. Giovanni in Laterano, is to be found across the Tiber from the center of ancient Rome in Trastevere, the district that has kept its name unchanged since antiquity. This was the riverfront, and the character of its life and people reflected the fact. Like Santa Susanna, the church was situated on a major street which led up the Janiculum hill to the beginning of the Via Aurelia. The early Christian church lies below its twelfth-century successor. Apparently there was a courtyard between the street and the church, set with its long axis parallel to the roadway. Originally the church consisted of a simple room 100 Roman feet by 58 Roman feet. The room had a series of arches opening into it from the east (that is, its short side). In the south wall there were two doorways. At this time the building resembled nothing so much as one of the warehouses of this riverbank quarter of the city. In a second phase the hall was lengthened (fig. 3.15). It was divided by a screen wall into two sections, the eastern one 78 Roman feet in length and a shorter one, 21 Roman feet, to the west. At this time a row of doorways, for which there is evidence of at least three, was

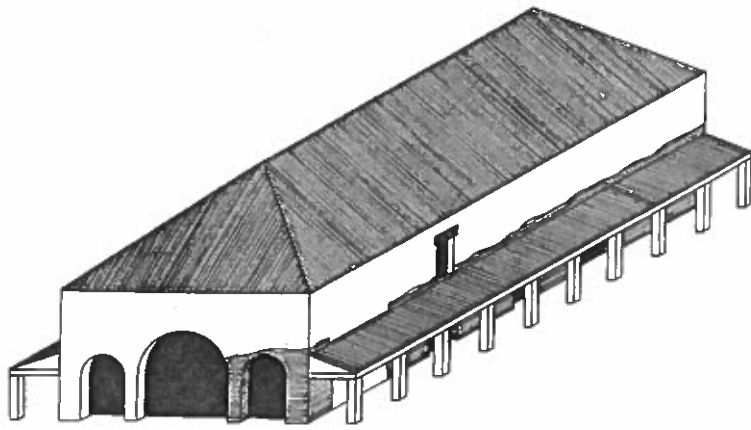

Fig. 3.15 S. Crisogono. Reconstruction of the second phase. After CBCR.

opened through the north wall giving onto the courtyard. There was a window above one of these. Finally in phase three the building was lengthened again so that the nave became 115 Roman feet long. Behind the entrance in the east a narthex was added. The apse was added and two side rooms. The southern member of this pair of rooms contained a font and was thus surely a baptistry.

It is possible, but not sure, that the original building was a church. If so, S. Crisogono would be the simplest kind of ecclesiastical building.<sup>32</sup> S. Andrea in Catabarbara (ex-Basilica of Junius Bassus) would be the nearest comparable church in Rome, but its transformation into a church did not occur until the fifth century. By its second phase, however, S. Crisogono was certainly a place of Christian worship. The masonry of the building favors a date in the first third of the fourth century; it can be compared, for example, to the masonry of the Basilica Nova and of S. Giovanni in Laterano. The third phase of its history belongs still to the fourth century.

A distinctive feature of S. Crisogono is the presence of porticoes on its two long sides. That of the south side could be original. The portico to the north, giving onto the courtyard entered from the street, belongs to the second phase of construction, when the doorways that connect it with the church were cut into the north wall of the building. This modification occurred still within the fourth century.

It is likely that the porticoes of S. Crisogono are connected to the conduct of Christian worship at the time. The early Christian community was not a unitary body. There were the baptized. And there were those waiting for baptism, the catechumens. The period of probation for the catechumens was far from short, lasting up to three years before baptism. The catechumens were not admitted to the mysteries of the Eucharist. They attended but before the consecration they were excluded from the service. Did they depart or were they in some other way separated from the baptized congregation? The openings to the exterior on the long sides of S. Crisogono may be interpreted as arrangements to permit the catechumens to withdraw before the begin-

ning of the culmination of the service. Such an interpretation gains weight by comparison with similar provisions found in other Roman churches. In the house church below S. Clemente, if the remains are interpreted properly, the openings in the side walls inherited from the Roman buildings on the spot were not closed up by the Christians. At Santa Croce in Gerusalemme the openings to the courtyard on one side of the nave remained open throughout the Middle Ages. In none of these cases did the doorways give directly on the street. They led rather to a courtyard or other protected area.

When the catechumens were present in churches without such arrangements, these buildings were provided with side aisles such as we find installed in Santa Susanna.<sup>33</sup> And a great new church like S. Giovanni in Laterano was also built with aisles.<sup>34</sup> In late antique buildings hangings were commonly draped in the openings of a colonnade.<sup>35</sup> When the drapes were open, the catechumens in the aisles could see as well as hear. When they were closed, they could hear but were prevented from seeing the mystery of the consecration.

The question of the origin of the Christian basilica can now be viewed from a viewpoint of strict functionality. A large room, otherwise unaltered, was fully acceptable as a place for Christian services. So much we learn from SS. Giovanni e Paolo and S. Crisogono.<sup>36</sup> The dignity of the altar and the clergy, however, was emphasized by a domed apse in every Roman church built or renovated from a preexisting building after the Peace of 312.<sup>37</sup> In the Christian church additional space for the clergy could be required around the altar. This need was clearly accommodated at San Giovanni without a true transept. The full transept, which gave the Christian church its cruciform ground plan, arose from the piecemeal development of S. Pietro in Vaticano, as we shall see below.

The distinction between the baptized and the catechumens, which necessitated their separation and the exclusion of the latter from the culmination of the service, was achieved either by provision of connection with areas outside the church proper or by the introduction of aisles within the church.

No architectural feature of the early Christian Church was there because it was inherited from an established pagan building type. The Christians could be satisfied with the simplest surroundings for their services. And even when success and recognition made their churches grander, the same churches remained simple and functional.<sup>38</sup>

### *The Lateran Baptistry*

Baptism at Rome in the fourth century was a solemn occasion. The years of preparation for the catechumen culminated at Easter, when the bishop repeated the rite first practiced by St. John the Baptist when he baptized Jesus in the river Jordan.<sup>39</sup> The baptistry of S. Giovanni in Laterano, octagonal on its exterior and centered on the baptismal font, is thus a building of particular importance (fig. 3.16). Today the interior of the baptistry is punctuated by an octagonal colonnade which divides the aisle from the center (fig. 3.17). This structure is the result of modifications made by Sixtus III (432–40), as are the elliptical antechamber and the portal of



Fig. 3.16 The Lateran Baptistery and post-Constantinian porch. Photo courtesy of Virginia Chieffo Raguin.

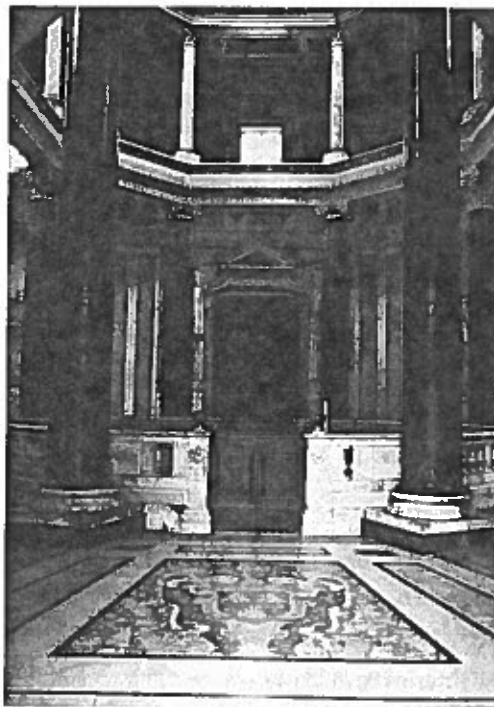

Fig. 3.17 The Lateran Baptistery, interior. Photo Rossa, DAI Rome, Inst. Neg. 75.1729. Copyright Deutsches Archäologisches Institut.

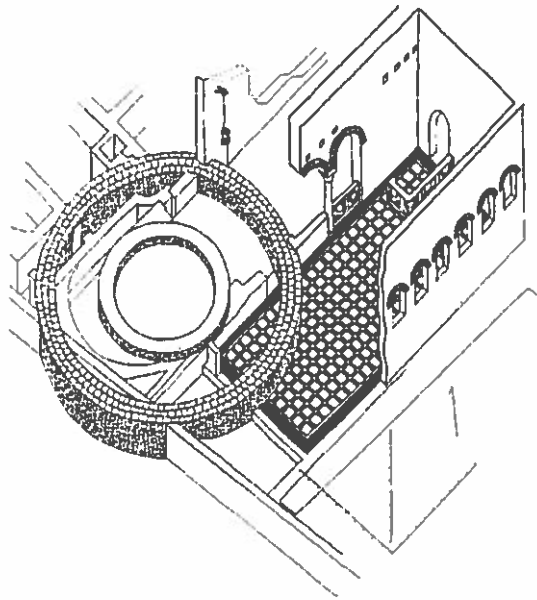

Fig. 3.18 The Lateran Baptistery, foundations and preexisting buildings. Reconstruction by O. Brandt. Courtesy Olof Brandt.

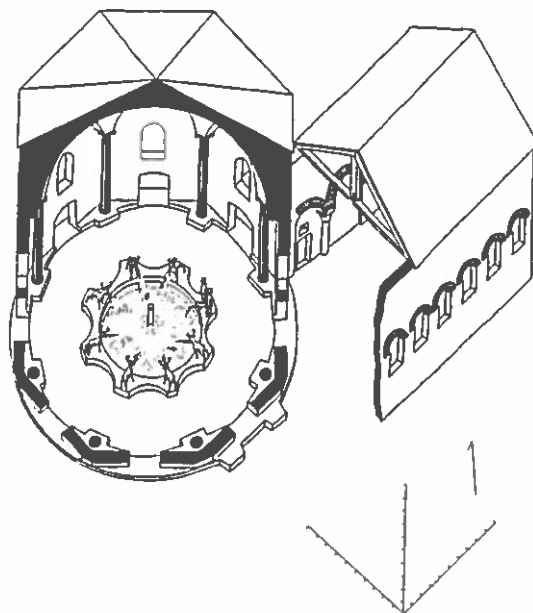

Fig. 3.19 The Constantinian Lateran Baptistery. Reconstruction by O. Brandt. Courtesy Olof Brandt.

the baptistry on its southeast side. Until recently it was thought that little or nothing remained of Constantine's baptistry. But this view has been challenged by Olaf Brandt on the basis of his work in the baptistry between 1995 and 1997.<sup>40</sup>

The baptistry was built on a circular foundation which gave it a diameter of 19 m (fig. 3.18). This ring was inserted into preexisting buildings of the Lateran property. In the center of the ring of the foundations there was a second ring for the font proper. When these two foundations had been prepared, the level was artificially raised and eight steplike foundations were built against the inner side of the main foundation while two others were placed on the exterior. These small foundations were intended to support columns. On the interior these were the same porphyry columns that were reused by Sixtus III for his remodeling. The small foundations were too small to hold columns of this size alone. The upper building, however, was to be not circular but octagonal (fig. 3.19). Placing an octagon on the circle of the foundations meant that where the segments of the octagon came together part of the foundation was not occupied. It is just at these points that the small foundations were placed so that they and the unoccupied surface of the foundations could carry the columns. The two small extra foundations on the exterior would have supported the columns of a porch.

The elevation of the baptistry, as one sees it today from outside, is thus the Constantinian building complete with flat arrises at the meeting points of the segments of the octagon. Of course, there have been changes and repairs. Originally, Brandt believes, there was only one range of windows rather than the two (blocked up) that one sees today. But the overall effect of the exterior is original.

How Constantine's building was roofed is open to conjecture. The porphyry columns set against the interior walls may have carried arches to support a dome.

The font is known in some detail from the passage in the *Liber Pontificalis* recording Constantine's dedication.<sup>41</sup> The font was porphyry covered with silver decoration. In addition:

In the center of the baptismal font there is a porphyry column topped by a golden basin where a candle is placed. It is of pure gold weighing 52 lb. And at Easter 200 lb of incense is burned by a wick of compressed asbestos. On the edge of the font there is a gold lamb from which water flows and which weighs 30 lb. And on the right side of the lamb the Savior in purest silver, 5 ft. high weighing 170 lb., on the left of the lamb is St. John the Baptist in silver, 5 ft. high, holding a scroll with the message, "Behold the Lamb of God—behold—that which lifts off the sins of the world." It weighs 125 lb. There are 7 silver stags from which water flows, each weighing 80 lb.<sup>42</sup> And an incense burner of purest gold with 48 green gems weighing 15 lb.

These sumptuous arrangements are suggested in Brandt's restoration of the baptistry when new.<sup>43</sup>

*The Basilica ad Corpus S. Pietro in Vaticano e S. Paolo Fuori le Mura*

With San Pietro in Vaticano we meet for the first time a *basilica ad corpus*, that is, a church raised over the tomb of a martyr.<sup>44</sup> The earlier history of the area and the question of the presence of St. Peter's tomb at or near the place of his martyrdom are questions best reserved for separate treatment.<sup>45</sup> By Constantinian times, however, this valley between the Vatican and Janiculum hills had long since ceased to be the location of the circus associated with the fate of the Christian martyrs of A.D. 64. The land on which the church was built was the site of a pagan cemetery. The large mausoleum which stood to the south of the nave of the Constantinian church, the Chapel of S. Andrea, is a Severan monument which also documents the decline and abandonment of the old circus.<sup>46</sup>

S. Pietro is in some ways the best known and the most poorly documented of the Constantinian churches. This is so despite the fact that the old church remained very little altered throughout the Middle Ages, only to be torn down to make way for the mammoth basilica raised by Michelangelo and his successors down to Carlo Maderno, the creator of the nave and façade. Drawings exist of the old church in various stages of demolition. Perhaps the most evocative is that of Giovanantonio Dosio done shortly after 1574 and showing the porch and nave of Old St. Peter's with the dome of the new basilica rising behind it (fig. 3.20). The section with perspective done around 1605 and found among the drawings in the Vatican Library, two of which are signed "Tasselli," shows the interior of the building and gives an idea of the interior and of the roofing.<sup>47</sup> The basilica fronted on an atrium. It was provided with double side aisles, a full transept, and an apse (fig. 3.21). The columns of the nave carried a flat architrave while those dividing the two aisles were topped by arches. There were twenty-two columns in each of the four rows, a medley of spolia from various sources. As we learn from the sixteenth-century architects Baldassare Peruzzi and Antonio da Sangallo, the columns of the nave were a mixture of granite (gray and reddish) and "onion skin" marble (the so-called Cipollino). The drawing of Cherubino Alberti is especially valuable in showing a base, column, and part of the architrave.<sup>48</sup> The transept was entered from the aisles through openings divided in three parts by two columns in each opening. A grand triumphal arch set off the transept from the nave. The exedrae at either end of the transept were also marked off by a pair of columns. Windows lit the interior from the nave clearstory and from above the transept.

It is impossible to give precise measurements for the building. Relying on the surveys of the Renaissance architects Alfarano and Baldassare Peruzzi, Krautheimer estimates the clear inner length of the nave as 90.78 m and the depth of the transept as 17.07 m, thus giving the length as 360 Roman feet. For the width of the nave and aisles there is also archaeological evidence. It is therefore possible to give the width of the outer aisles as 9.83 m and that of the inner aisles as 9.21 m. In neither of these cases are the measurements of sufficient precision to allow exact conversion into Roman feet.<sup>49</sup> The width of the nave can be estimated to be 63.42 m,



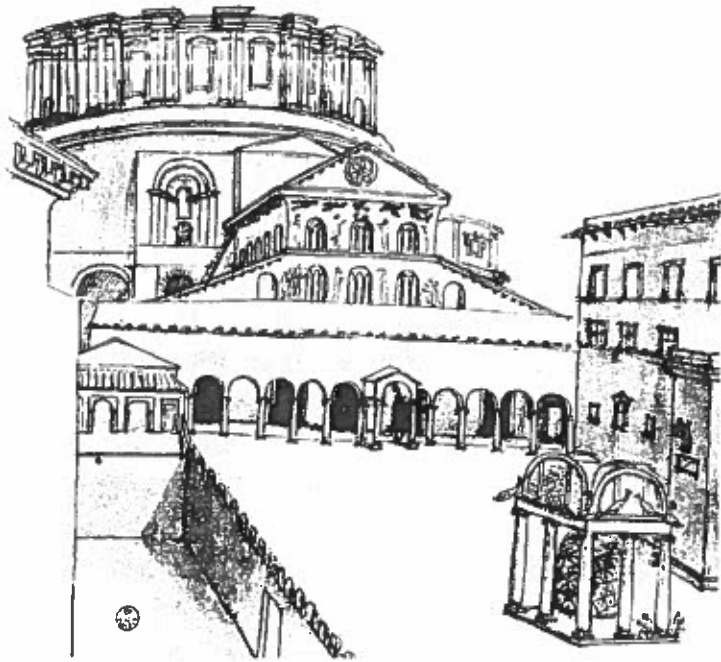

Fig. 3.20 Old S. Pietro in Vaticano. The Constantinian church and the drum of Michelangelo's dome. Drawing by Giovanantonio Dosio, Berlin, after H. Egger, *Römische Veduten*.

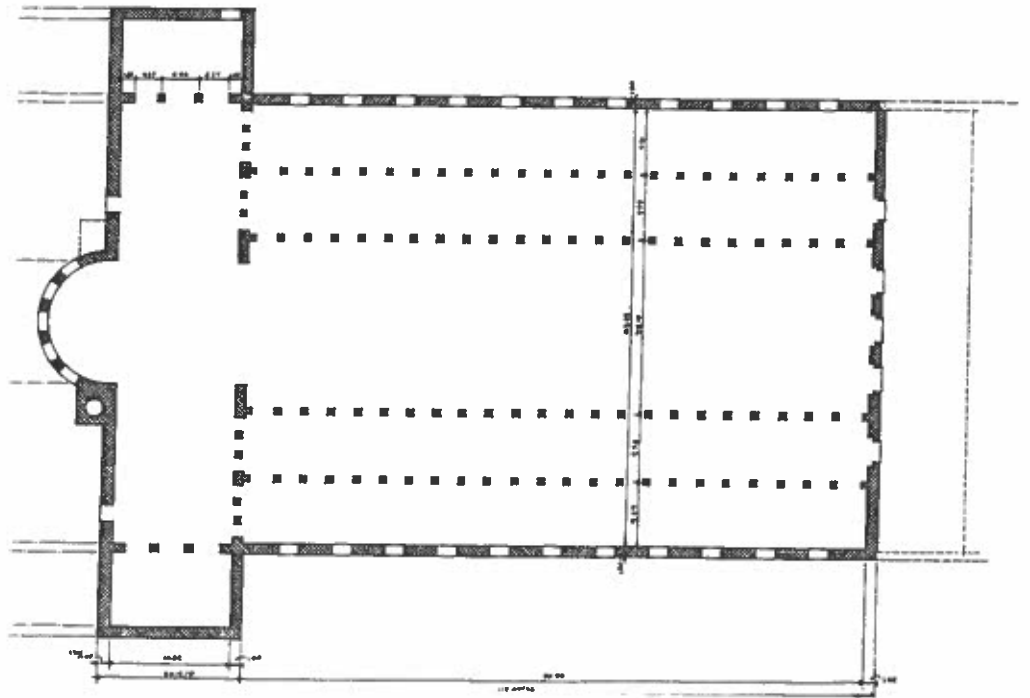

Fig. 3.21 Old S. Pietro in Vaticano. Plan. After CBCR.

80 Roman feet. The nave and aisles together make a width of 212 Roman feet. The total width of the transept is 90.95 m. The apse diameter may be estimated at 17.39 m.<sup>50</sup>

S. Pietro was oriented east–west with its apse toward the west. The foundations were made with great care owing to the problems created by the location of the building on a hillside. This required making a substantial cut in the slope of the Vatican hill to the north and creating a platform with deep foundations toward the south, where the Circus of Nero was originally located. It was during this work that the pagan mausolea under the nave of the present basilica were intentionally filled after their tops had been leveled off. Parts of five foundation walls have been uncovered under the nave. They are the south exterior wall, the walls under the two rows of columns in the southern half of the nave and those under the two corresponding rows of columns on the northern side of the basilica, also the west wall of the church and its apse and the wall separating the transept from the nave. A number of walls were also built across the mausolea and passageways of the necropolis underlying the building. These are much thinner than the bearing walls (0.6 m as against 3.5 m). The pavement of the nave was made up of square and rectangular marble slabs and filled out with small, irregularly shaped pieces of the same material.

A revolutionary rethinking of the evolution of the plan of S. Pietro has now been proposed by Carpiceci and Krautheimer.<sup>51</sup> Their argument comes from the observation that the east wall of the transept (toward the nave) had the same carrying capacity as the other walls of the transept and was thus originally intended to be an exterior wall. In its first phase, therefore, the transept was a rectangular building enclosing the apostle's tomb. There was no nave at all. When the nave was built, it had only two side aisles. This additional revision in our thinking about the church is also based on the evidence from the foundations. In fact, the foundations of the colonnade separating the two side aisles of the basilica as it finally came to be are more stoutly built than the foundations under the two colonnades flanking the nave itself. This is because, Carpiceci and Krautheimer suggest, the heavier foundations originally supported an exterior wall. When the basilica was enlarged they were used for the colonnade separating the aisles.

This revision of the history of the plan of the church has important implications for the history of the Christian basilica. S. Pietro is the first basilica with a transept (fig. 3.22). The transept, however, arose from the addition of a nave to a preexisting martyrion. The transept proved useful for the functions of the church and thus became an integral feature of basilica design.<sup>52</sup>

During the building operations of the sixteenth century the nave was divided crosswise by a wall to protect the area where the dome was in course of construction. This wall contains plinths and column bases from the screen that closed off the northern wing of the transept and from the north aisle of the nave of the old basilica.

The honor paid to the apostle's tomb was revealed by the excavations carried out after 1940.<sup>53</sup> The simple niche that had marked the supposed grave of St. Peter was enclosed in a grand white marble casing banded in porphyry (fig. 3.23). This monument stood fully 2.5 m

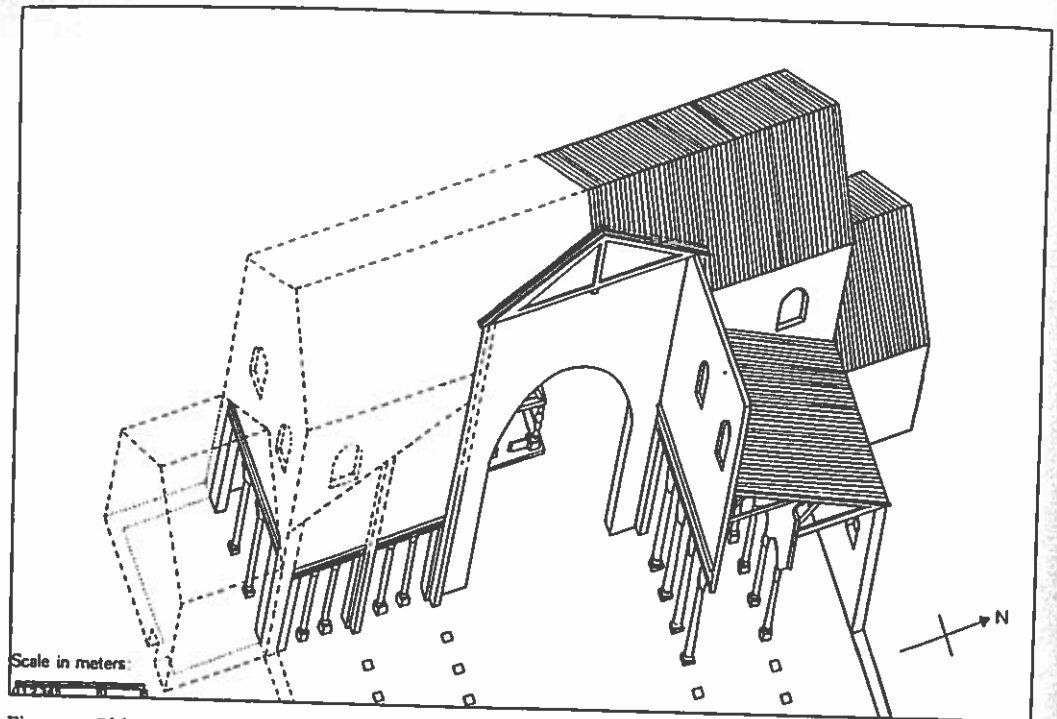

Fig. 3.22 Old S. Pietro in Vaticano. Reconstruction of the west end of nave and transept. After CBCR.

high.<sup>54</sup> The marble columns encircled by vine scrolls that flank the niches of the great piers supporting Michelangelo's dome which face inward toward the Papal Altar beneath Bernini's baldacchino appear to come from this tabernacle of the old basilica and are Roman work of the fourth century (fig. 3.24).<sup>55</sup>

Several inscriptions copied in Old St. Peter's bear on its foundation. The first was to be read, though with difficulty, on the triumphal arch until 1506: "Because with You as our Leader the world rose to the stars, Constantine the victor in triumph founded this hall for You."<sup>56</sup> In the apse of the church there was another inscription copied during the Middle Ages: "What you see is the seat of justice, the house of faith, the hall of decorum. It is piety that is the possession of every thing which famously rejoices in the virtues of the Father and of the Son and makes equal its Author with the praises given the Father."<sup>57</sup> This later inscription, which has been used to support the theory that Constantius II rather than Constantine founded the church, should rather be read with reference to the Trinity.<sup>58</sup> To be sure, the record of the foundation attributed to Constantine in the *Liber Pontificalis* is clouded by the possibility of confusion between Constantine and his sons. But an important piece of evidence for the earlier date of the basilica does occur in the *Liber Pontificalis*, in which we read that Constantine donated a gold cross inscribed by himself and his mother with the following inscription: "Constantine Augustus and Helena Augusta. He surrounds this house making / it gleam regal in its splendor with a hall."<sup>59</sup>

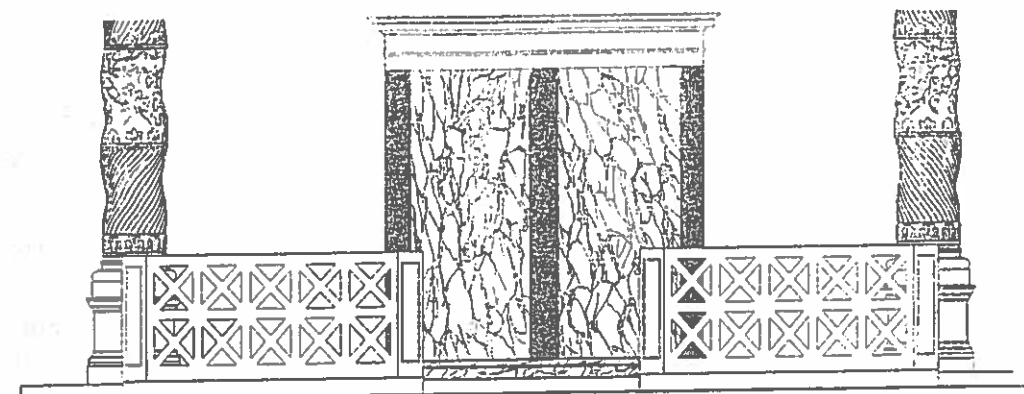

Fig. 3.23 Old S. Pietro in Vaticano. Reconstruction of the Constantinian monument around the Tomb of St. Peter. After *Esplorazioni*.

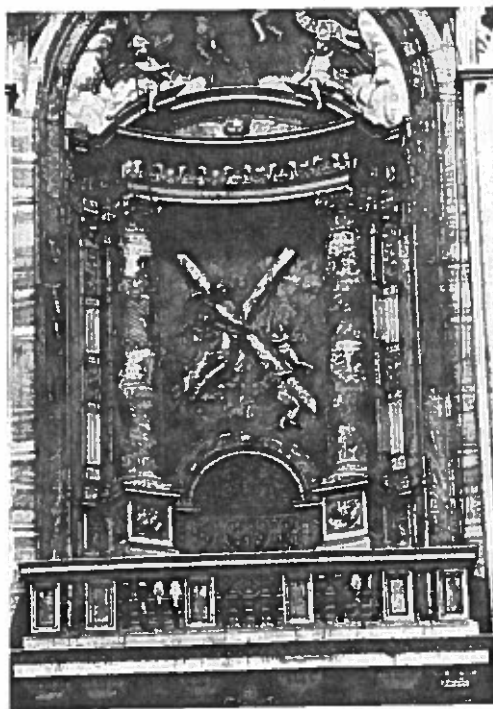

Fig. 3.24 S. Pietro in Vaticano. Surviving spiral columns from the Constantinian monument around the Tomb of St. Peter reused in the Renaissance Basilica. Photo Schwanke, DAI Rome, Inst. Neg. 79.3525. Copyright Deutsches Archäologisches Institut.

s  
s  
f  
  
a  
r  
t  
-  
l  
s  
e  
-  
n  
of  
a  
e  
r

The church was endowed with the income from properties in the eastern part of the empire which came under Constantine's control only after the defeat of Licinius in 324.<sup>60</sup> But the building of the basilica could have been started earlier. In any case the evidence of the inscription on the gold cross shows that it must have been finished before Helena's death before 330.<sup>61</sup> In the thinking of Carpiceci and Krautheimer both the martyrium and the basilica were built before 324, although the decoration of the basilica may have been completed only at a later date.<sup>62</sup>

The grand basilica over the tomb of the Prince of the Apostles was, after San Giovanni in Laterano, the major gift of Constantine to Christian Rome. It reproduced and perfected the basilical type introduced at San Giovanni in Laterano. In size it magnified the plan of San Giovanni, being fully one-third larger in every dimension than the seat of the bishop of the city. Almost by accident it created the transept found so widely in subsequent Christian churches. Proof that early Constantinian basilicas in the neighborhood of Rome existed without transepts has now been provided by the recent discovery of such a basilica of Constantinian date at Ostia (fig. 3.25).<sup>63</sup>

During its planning and construction San Pietro remained a work in progress. It is well worth noting the judgment on the building expressed by those scholars who in the twentieth century may be said to have known it best:

From this study there emerge the two faces of the first Basilica. The first is what makes it one of the most important monuments of western architecture, the true archetype of Christian churches, an organism remarkable for its perfect functionality stamped by the first great Christian community. The second aspect lies in its modest claims to architectural and ornamental distinction in comparison with the important buildings of the period. Indeed, Old Saint Peters was an edifice built on a plan that was not perfectly symmetrical, disjointed in its individual parts and made up of a succession of high and weak walls held up by secondhand columns taken from the leftovers of marble depots with bases and capitals often mismatched or unfinished.<sup>64</sup>

But San Pietro was not a church in the same way that San Giovanni was. Instead of an altar at the focal point of the building where the nave met the transept there stood the porphyry and marble tomb monument of St. Peter. The celebration of the Eucharist was subordinated to the memorial of the apostle and must have been celebrated on portable altars. This building was, first and foremost, a vast covered cemetery.<sup>65</sup> The necropolis on the site continued as a Christian burial ground below the floor of the church. Viewed from the standpoint of pagan Rome, the magnetism of the martyrs and especially of the martyrs' graves for the early Christians is a peculiar phenomenon. True, in distant times the ancient world had known heroes who kept a watchful and beneficent eye on their countrymen from the tomb and who would, on

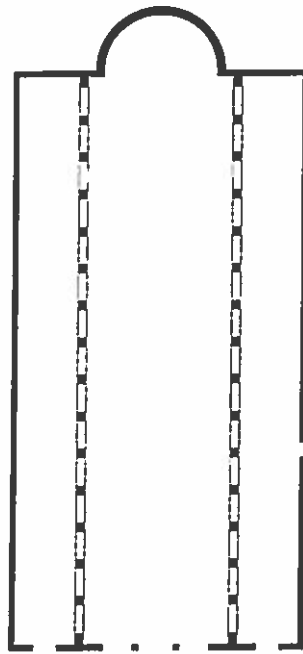

Fig. 3.25 Ostia, plan of the early Christian basilica. Courtesy Michael Heinzelmann.

occasion, emerge to fight by their side in moments of critical danger. True, in Latium of the centuries when Rome was little more than a group of villages on their individual hills the burials of the members of a clan would crowd around the tomb of their progenitor. But such customs and superstitions had long since lost their force. The cult of the Christian martyrs was something new.

The Christian fervently believed that death was not a finality. "We shall not all sleep, but we shall all be changed. In a moment, in the twinkling of an eye, at the last trumpet: for the trumpet shall sound, and the dead shall be raised incorruptible, and we shall be changed."<sup>66</sup> Among the Christian dead, the martyrs enjoyed unquestioned sanctity. The martyrs, moreover, enjoyed a special proximity to divine grace. Their souls awaited the Last Judgment and reunion with their earthly bodies beneath the altar of Heaven.<sup>67</sup> Christ Himself, furthermore, dwelt within the martyr.<sup>68</sup> Demons and devils trembled before their remains.<sup>69</sup> Nurtured on the scriptural reports of the miracles worked not only by Jesus but by the apostles and within the power of the saints, it is no wonder the Christians assumed that grace would come to them through these ministers of the Almighty and contact with or proximity to those very earthy remains with which the souls of the martyrs were so soon to be reunited.<sup>70</sup> The windows opening onto the repositories of the relics—for example, the simple confessional tucked in under the stairwell of the Christian meeting place under SS. Giovanni e Paolo—served the faithful to

lower charms which by contact with the relics of the saint acquired some of their miraculous power. Cloths were considered especially useful for absorbing potency from contact with the bones against which they brushed.<sup>71</sup> An opening of the kind found at SS. Giovanni e Paolo permitted similar access to the grave below the marble and porphyry monument in the center of San Pietro. Needless to say, burial in the vicinity of a martyr was a much sought after advantage among the Christians.

The cemetery, moreover, was the focus of an important Christian ritual. This was the periodic commemoration of the dead at the tomb accompanied by a feast and by a celebration which frequently reflected the conviviality of the occasion, the *refrigerium*.<sup>72</sup> It was inherited from the pagan commemoration of the dead in which on various occasions through the year the family gathered to eat and drink in a spirit much more that of a holiday than of mourning. These affairs were marked "not [by] sadness or silence, but joyfulness, a carefree tone and dismissal of the enmities and disputes which, then as now, trouble families."<sup>73</sup> And so the Christians, especially after the Peace of 312, made their refrigeria in abundant eating and drinking.<sup>74</sup> And *dignitas* was not always maintained. At St. Peter's there were daily and conspicuous scenes of immoderation.<sup>75</sup> True to the Master's teaching, however, the Christians extended their hospitality to the poor, orphans, and widows. An especially large number of participants gathered at St. Peter's in 397 for the refrigerium in honor of Paulina, wife of Pammachius.<sup>76</sup> Episcopal opposition to this custom, not only at Rome but throughout Christian lands, is understandable. It was responsible, however, for the building of a series of extramural basilicas at Rome that I shall consider shortly.

As buildings, San Giovanni and San Pietro were the two poles of monumentalized Christianity in Constantine's Rome. One was the seat of the bishop. The other was the justification of that same bishop's primacy, a monument to the succession from Peter himself, the rock on whom Jesus had promised to build His church. San Giovanni was a Christian church as we understand it; San Pietro was a covered cemetery and memorial of the Prince of the Apostles. It was a gathering place for those meals in commemoration of the dead that were so beloved by the Roman Christians. The celebration of the Eucharist appears, from the archaeological evidence, to have been a secondary consideration.

One might have expected similar honor for St. Paul, but the arrangements in Constantine's day for his tomb at the location of his martyrdom on the Via Ostiensis south of the city appear to have been modest in comparison to the monument for St. Peter.<sup>77</sup> The building of the basilica is attributed to Constantine by the *Liber Pontificalis*.<sup>78</sup> The passage, however, has all the indications of an interpretation intended to make San Paolo appear as old and rich as San Pietro.<sup>79</sup>

The early Christian basilica for St. Paul, in the form given it during the reign of Theodosius I in 384, survived almost unaltered until 1823, when it fell victim to a disastrous fire. The old church was extensively documented even before the fire, and following it, in the few years before reconstruction began in 1833, other drawings were made of the building in its ruined state. Like San Pietro, the basilica proper was preceded by a colonnaded atrium and porch.

There were two side aisles on each side of the nave. There was a transept with abbreviated arms and an apse in the rear (east) wall.<sup>80</sup>

The two rows of columns flanking the nave began with a pair of columns with white marble shafts placed just inside the door. Then there followed eleven pavonazetto columns in the northern row and thirteen in the southern row. The subsequent eight columns north and six south are once again of white marble. Three of the Corinthian capitals were of Severan date. The rest appear to be of the late fourth century.<sup>81</sup>

The transept was raised above the nave. But originally the paving may have been uniform and the columns here cut down at a later date when the paving was raised. There were three round arched windows above each side of both wings of the transept, and above these there were additional round windows (three in the west wall, two or three in the east wall).

This late antique building went through a series of phases, and a key to these is provided by the history of the structures over the tomb of St. Paul below the high altar. These have been significantly reworked. Two blocks of the present upper step of the structure over the tomb have the inscription "Paulo Apostolo Mart." on their upper surface (fig. 3.26). They are not in their original location. They were originally intended to be placed upright with hanging lamps suspended from them (as shown by a number of small holes along their lower edges where the hooks for the lamps were inserted).<sup>82</sup> The other components of this structure are missing and would have carried the name of the donor that preceded the remaining words. The inscription is apparently late fourth century or fifth century in date, making it contemporary with the Theodosian church.<sup>83</sup>

The remains below the level of the two marble courses were uncovered in 1838 and are known only from the sketches made at the time.<sup>84</sup> These show a base of two finished courses and above them a grill protecting a cavity some 0.223 m deep. It is important to note that the grill faces not the Via Ostiensis but the byroad that branched off from it and ran obliquely toward the Tiber. It can be assumed that the church originally faced toward the Tiber too, so that the worshiper entering the building from this direction could approach the apostle's shrine directly and have access to its wonder-working properties through the grilled fenestrella. What this building was like in plan or dimensions it is impossible to say.

The traces of the first apse of the church, however, exposed in 1850, belong to a building that had changed direction so that it now faced away from the river and toward the Via Ostiensis. Finally, when the Theodosian church was built in 384 once more it changed its axis 180 degrees and again faced back toward the Tiber. It is this church that we know as the S. Paolo destroyed in 1823.

The dating of the initial phases of the basilica is extremely difficult. If one discounts the testimony of the *Liber Pontificalis*, there is little to guide one in dating the first phase of the building or its successor facing the Via Ostiensis. Furthermore, the size and plan of these two first shrines to the apostle are a matter of conjecture.

Both S. Pietro and S. Paolo are testimony to the cult of the martyrs in early Christian





Fig. 3.26 S. Paolo fuori le Mura. Inscription to the apostle on structure below the high altar. Photo Fototeca Unione Neg. 5906. Copyright.

Rome. S. Pietro was rapidly enlarged and in addition to the tomb of St. Peter housed a large covered cemetery. In Constantine's Rome far greater energy and expense were devoted to the construction of such covered cemeteries, *coemeteria subteglata*, than to that of churches. The other monuments of this type, to which I now turn, were grand in themselves, and they created another early Christian architectural tradition. But, strange to relate, they had completely vanished from sight (or had been made indistinguishable from churches of more recent centuries) until rediscovered by archaeological investigation.

#### *Coemeteria Subteglata and Mausolea*

##### VIA LABICANA

Constantine prepared his tomb on the road which issues from Rome just to the north of S. Croce in Gerusalemme through the present-day Porta Maggiore.<sup>85</sup> This is the Via Labicana, and he chose the location at five kilometers (slightly under three miles) outside the city on part of the imperial property known as "ad duos lauros."<sup>86</sup> The tomb, traditionally known as Tor Pignatara, was a brick rotunda standing in the long-established line of gigantic round imperial tombs beginning with the mausoleum of Augustus and perpetuated in the later empire under the influence of the Pantheon (fig. 3.27). The lower drum is preserved for more than half of its circumference. The upper drum was pierced by arched windows which were recessed in tall domical niches on the exterior. The cupola is not preserved, but the height of the structure up to its springing is 21.09 m. The interior diameter of the mausoleum is 20.18 m, and the exterior, 27.74 m. The walls of the interior were covered with incrustation, of porphyry as well as of colored marbles, as shown by the clamp holes still visible on the wall faces. These were

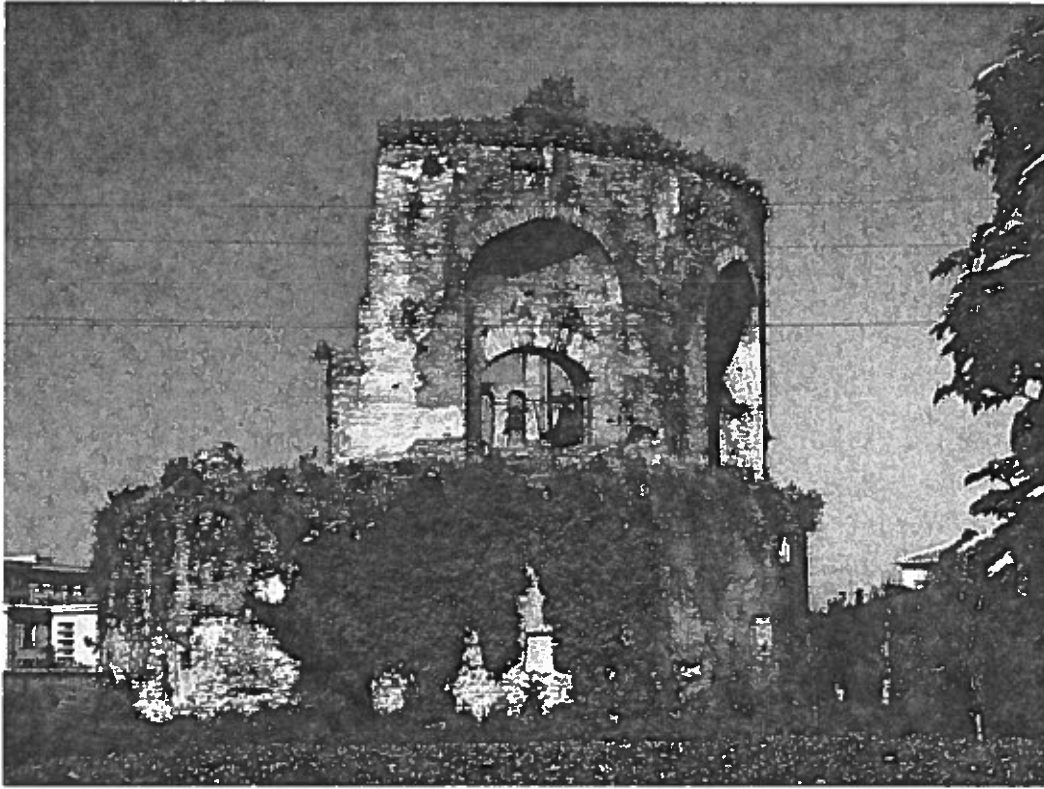

Fig. 3.27 Via Labicana, Tor Pignattara (Tomb of St. Helena). Photo Fototeca Unione Neg. 1126. Copyright.

applied to a wall articulated by a series of niches around the lower drum answered by the arched openings of the windows above. The niches were fitted with mosaics, some parts of which could still be made out in the sixteenth century, as was the interior of the dome.<sup>87</sup> The exterior was plastered.

According to the *Liber Pontificalis*, it was not Constantine but his mother, the empress Helena, who was buried in the mausoleum ad duos lauros.<sup>88</sup> Her porphyry sarcophagus still survives in the Vatican (figs. 3.28, 3.29). The sarcophagus, decorated with masculine scenes of a victorious battle with barbarians, offers the clearest evidence that the mausoleum was prepared as Constantine's own tomb before he decided to transfer the capital of the empire to Constantinople and make a resting place for his earthly remains in the Church of the Holy Apostles.<sup>89</sup>

The imperial mausoleum does not stand alone. It is connected directly to a long apse-ended structure, the basilica of SS. Marcellino e Pietro. Constantine, according to the *Liber Pontificalis*, provided handsomely for both, although twice as much gold and silver was lavished on the mausoleum as was given to the other.<sup>90</sup> By the sixteenth century almost nothing was to be seen of the basilica, and aside from Antonio Bosio's plan of the apse made in 1594,<sup>91</sup> what we know of it comes from the excavation carried out since 1940 by Friedrich Wilhelm Deichmann and Arnold Tschira and then by Jean Guyon. The basilica is 65 m in length and

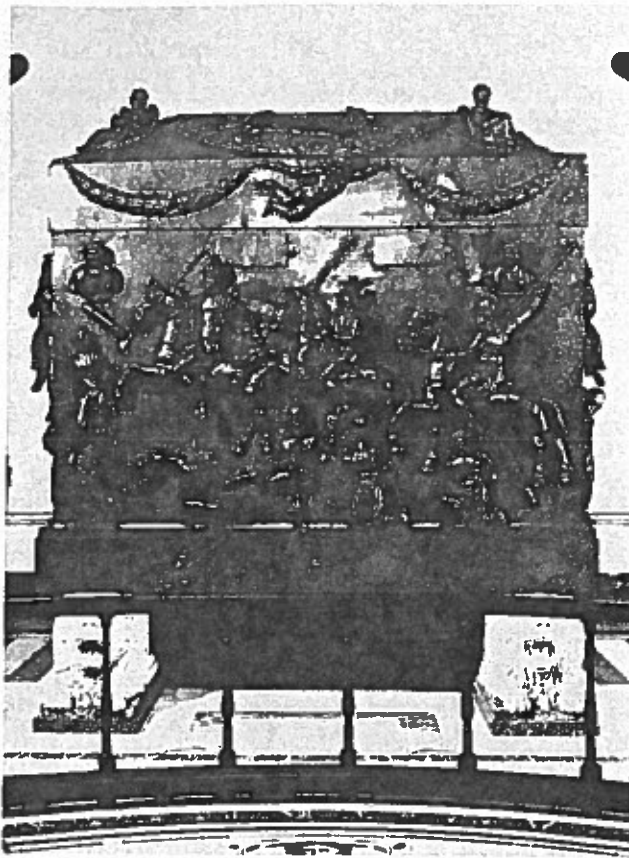

Fig. 3.28 Sarcophagus of St. Helena. Vatican Museum. Photo Como, DAI Rome, Inst. Neg. 63.2339. Copyright Deutsches Archäologisches Institut.

29 m in width (figs. 3.30, 3.31). The apse and ambulatory are features which characterize this building and the others of the same type erected, often in connection with mausolea, in the Constantinian period. The apses of churches in the tradition of San Giovanni are clearly conceived as an addition to the flat rear walls of churches, but in these buildings the side walls continue to form the apse end, thus giving them a full ambulatory including the side aisles.<sup>92</sup> The side aisles are 6.5 m in width; the nave is 13 m wide. The narthex of the basilica, 6.5 m deep, is attached directly to the mausoleum.<sup>93</sup> In the foundations of the walls, which consisted of a rubble fill in trenches cut in the tufa bedrock, there were found blocks apparently coming from mausolea of the Republican period in the neighborhood, notched bricks frequently found in mausolea of the imperial age, and many fragments of stelae belonging to the tombs of the Equites Singulares, the force suppressed by Constantine whose cemetery had been located here.<sup>94</sup> Fragments of painted plaster from the interior of the building show that the walls were painted.<sup>95</sup>

South of the basilica, between it and the Via Labicana, there was a large portico. This was



Fig. 3.29 Sarcophagus of St. Helena. Vatican Museum. Photo Como, DAI Rome, Inst. Neg. 63.2340. Copyright Deutsches Archäologisches Institut.

matched by a similar enclosure to the north, which, however, seems to have had no more than a perimeter wall. Guyon, the most recent investigator of the remains, reconstructs the outer wall of the southern portico and the perimeter wall of the northern enclosure as forming the original boundary of a single enclosure. This he identifies as the cemetery of the *Equites Singulares*.<sup>96</sup>

The complex of basilica and mausoleum was entered from the Via Labicana through a doorway at the southeast corner of the south portico. The visitor proceeded along the covered passage of the portico to the southeast corner of the nave of the basilica. Entering the building at this point, he was a few steps from the openings to the narthex. To his right was the narthex and beyond it the rotunda of the mausoleum, to his left, the nave of the basilica and its apse. It is clear, therefore, that the mausoleum was never a freestanding building but always part of the basilica complex. Both monuments are Constantinian in brickwork and are mentioned together in the *Liber Pontificalis*.<sup>97</sup> The brick stamps from the mausoleum are generically Constantinian. A coin found in the mortar of the marble revetment of the interior

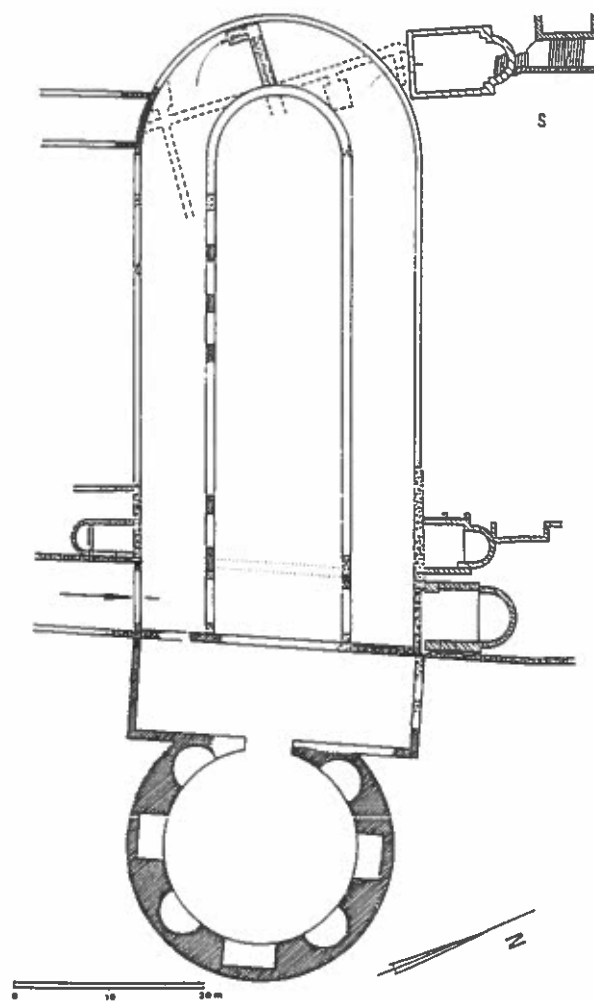

Fig. 3.30 Via Labicana, Tor Pignattara. Apse-ended basilica and mausolea. Plan. After *Felix Temporis Reparatio*.

belongs to the series of 324–26. Its presence in the mortar must represent a very late stage of work.<sup>98</sup>

The area within the portico and northern enclosure was one large graveyard. Burials in simple cist graves, *formae*, were also crowded into the covered passages of the southern portico. In addition, six small mausolea were built in these enclosures, five of them abutting the walls of the basilica or portico. Four other mausolea have been identified to the west of the enclosed area. All were packed with burials in the floor. Niche burials under arched openings in the walls, *arcosolia*, are also documented, and there are also two fragmentary decorated marble sarcophagi. Considering the depredation that these cemeteries had suffered, there were once certainly many others.

The basilica was also a covered cemetery. The tombs found during the excavations are

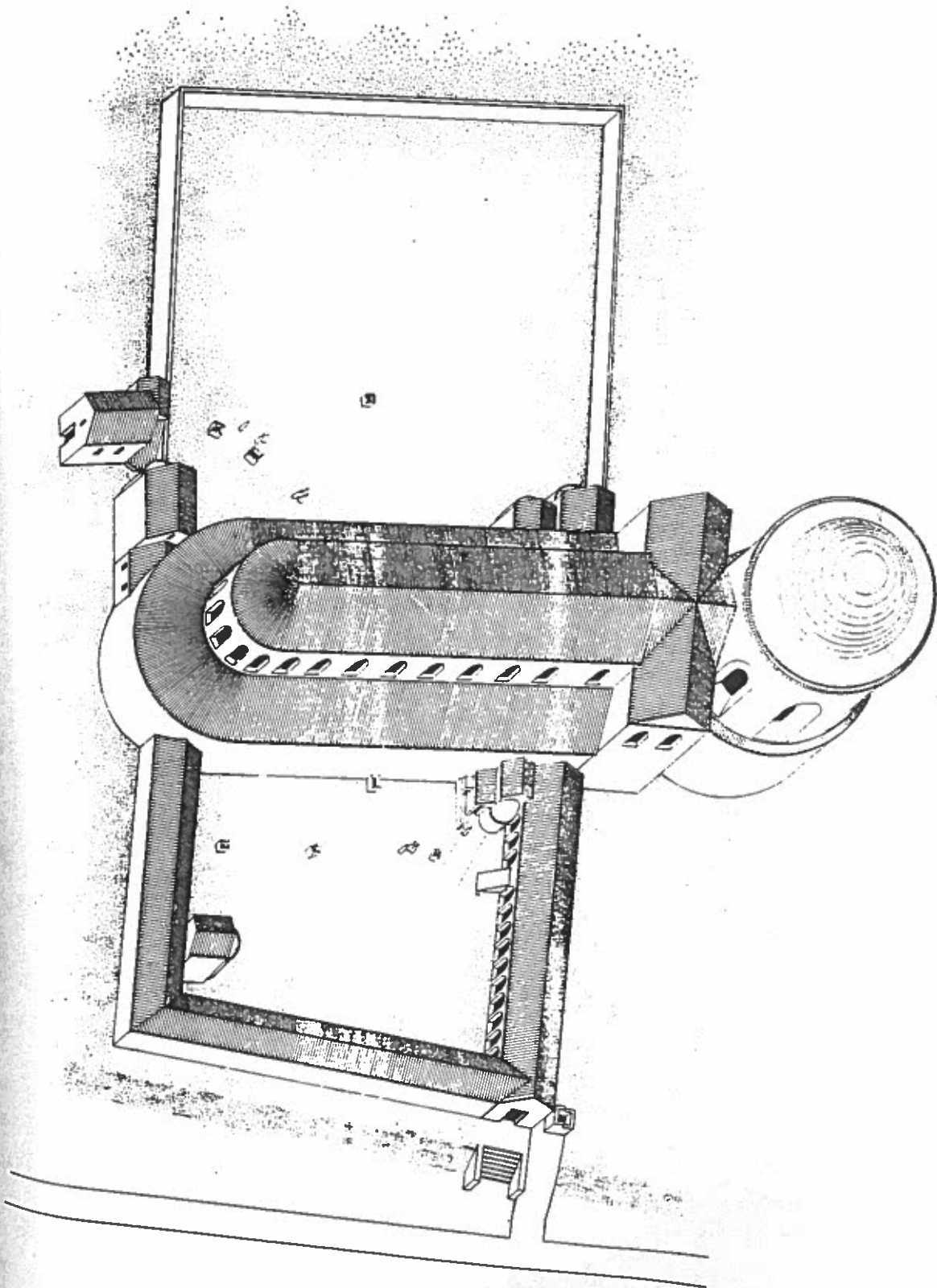

Fig. 3.31 Via Labicana, Tor Pignattara. Apsè-ended basilica and mausolea with adjoining porticoes. After Guyon, *Le Cimetière aux deux lauriers*.

medieval (covered with masonry vaults) and seem to have been made when the church was already abandoned and roofless.<sup>99</sup> The find of fragments of Constantinian gravestones, however, shows that burials were made inside from the beginning.

Finally, the catacombs of SS. Marcellino e Pietro were actively used and expanded during the Constantinian period. The aboveground structure located at the north corner of the apse of the basilica may be interpreted as the chapel of the martyrs who gave their names to the cemeteries. In the catacombs just below this room, which might easily be mistaken for another mausoleum were it not for the lack of burials inside, there is a large chamber reinforced with brickwork walls and arches. On one side there are two loculi, and a graffito nearby hails the martyrs Marcellinus the deacon and Petrus the exorcist. The cemetery *ad duos lauros* was alive with martyrs, some fifty in all.<sup>100</sup> The history of the relation of Marcellinus and Peter with the cemetery (to which their remains were moved at some unspecified date) is complicated, but the archaeological evidence shows that they were venerated here from Constantinian times and before.<sup>101</sup>

Guyon estimates that approximately eight thousand burials, or half the total number in the catacomb, were made after 325. There were possibly another one thousand in the basilica, the same number under the porticoes of the southern enclosure, and five hundred or so in the mausolea plus an indeterminate number in the open spaces of the north and south enclosures. These numbers include all burials made throughout the life of the cemetery, which continued in use until the early ninth century. It is interesting to observe that there were no graves beyond the imperial mausoleum east of the old enclosure wall of the cemetery of the *Equites Singulares* with one exception, and that a grave placed immediately beside the enclosure wall.

The complex at SS. Marcellino e Pietro seems both impressively planned and curiously irregular. Neither the southern porticoed court nor the northern enclosure have strictly parallel sides, although this is due to the form of the enclosure for the cemetery of the *Equites Singulares*. And although its narthex is centered on the imperial mausoleum, the basilica is canted at an odd angle to it.

Yet obvious circumstances caused these irregularities. The axis of the imperial mausoleum through its doorway is oriented perfectly in respect to the *Via Labicana*. But the front wall of the nave of the basilica (or rear wall of the narthex) employed the old enclosure wall of the cemetery of the *Equites Singulares* for its foundation. This wall ran at a slightly obtuse angle to the perpendicular from the *Via Labicana*. The basilica was set farther askew with regard to the same perpendicular which governed the siting of the mausoleum. The reason for this additional divergence from the orientation of the mausoleum must lie in the position of the martyrdom of Saints Marcellino and Pietro. For obvious reasons the builders of the basilica were concerned not to run the line of the apse foundation too close to the large underground shrine of the martyrs.



Fig. 3.32 Via Nomentana, S. Costanza and adjoining apse-ended basilica. Photo Felbermeyer, DAI Rome, Inst. Neg. 41.2588. Copyright Deutsches Archäologisches Institut.

But to the visitor to the imperial mausoleum and its adjacent buildings, the basilica, the portico, or the catacombs these variations from strictly axial planning made no difference at all. His progression through the south portico to the basilica or mausoleum was controlled by interior spaces which gave the impression of axuality while they displayed the sumptuous honor accorded to the mother of the emperor and to the martyrs.

#### VIA NOMENTANA

On the Via Nomentana, well beyond the gate in the Aurelian walls of the same name, was the catacomb associated with the tomb of St. Agnes. The small basilical church of the early seventh century is well known, as is the round church of Santa Costanza nearby. What was not realized until the excavations of the 1950s was that the massive structure to the north of Santa Costanza was in reality the apse of an apse-ended basilica to which the church was attached about halfway along its western side (fig. 3.32).<sup>102</sup> The apse itself is a mighty construction placed at the edge of the terrace it shares with Santa Costanza and therefore requiring deep foundations beneath it. It is preserved to a height of two stories. The interior was



illuminated by large windows in both side walls and apse proper. The building is known only in its barest outlines. It measures 98 m in length and 40 m in width. The plan is the same as that of the basilica of the Via Labicana with the addition of an atrium before the entrance. There are also foundations for a second apsidal enclosure within the curve of the ambulatory colonnade.

The church of Santa Costanza in the parklike setting of the Via Nomentana, two miles outside the Aurelian walls of Rome, seems to be a virtually unchanged survival of the Constantinian age (fig. 3.33). The round building is complete save for what was supported on an outer ring of foundations. It is connected to the apse-ended basilica by an elliptical fore chamber. On the interior, the ambulatory with its barrel vault carrying its famous mosaics opens to the center through a series of arches supported by pairs of columns rather than by piers (fig. 3.34). The columns have carefully chosen but not matching Corinthian capitals. The ring of arches supports the drum, which gives a spacious height to the interior and light through its large windows. The interior diameter is 22.5 m, and the drum rises to a height of 19 m above the floor (fig. 3.35). Here, if anywhere, is a taste of an interior of Constantinian Rome alive with the color and the interlacing designs of its mosaics in the vault over the ambulatory. The shadow of the corridor makes a sensible contrast with the openness and light-filled volume of the drum, whose weight is carried so easily by the arches and small columns separating them. Finally, in the rectangular niche directly across from the entrance, there stood the grand porphyry sarcophagus adorned with cupids tramping out the vintage. Briefly removed in 1467–71, it has since the eighteenth century been preserved in the Vatican Museum (figs. 3.36, 3.37).<sup>103</sup> There are seven other niches on either side of this rectangular niche. The center of each group is occupied by a larger semicircular niche.

Yet the idea that Santa Costanza is an unchanged treasure of Constantinian times should not be accepted without reservation and without realizing that a tangle of problems surround this monument and its interpretation. First there is the question of the mosaics, both those of the ambulatory admired by every visitor to the building and those of the upper part of the drum which had deteriorated badly by the early seventeenth century when they were removed.<sup>104</sup> Even the mosaics in the vault of the ambulatory are not precisely as they were when originally installed. What we see is a nineteenth-century restoration carried out between 1836 and 1843. A close study of the accounts of the work has shown that no more than 30 percent of the original surface was intact when the project began.<sup>105</sup> Naturally the symmetrical and repetitive nature of the designs as well as the care with which the work was carried out means that the overall effect is consistent with what originally existed.<sup>106</sup> But the restorers' work in some cases led to a simplification of the original design.<sup>107</sup>

The sequence of panels is symmetrical on either side of the panel immediately above the door (I) and can be summarized as follows:

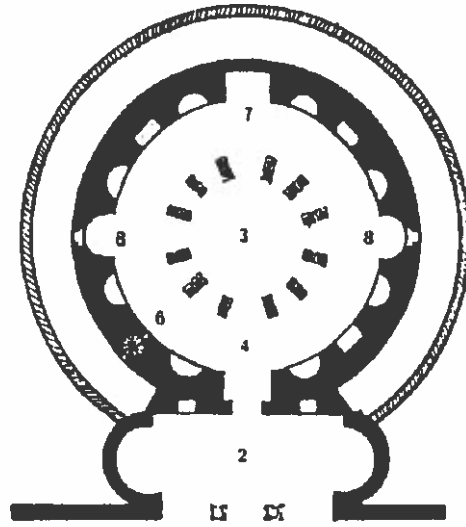

Fig. 3.33 Via Nomentana, S. Costanza. Plan.  
After Cecchelli, *S. Agnese fuori le Mura*.



Fig. 3.34 Via Nomentana, S. Costanza. Interior.  
Photo Bartl, DAI Rome, Inst. Neg. 57.1201.  
Copyright Deutsches Archäologisches Institut.

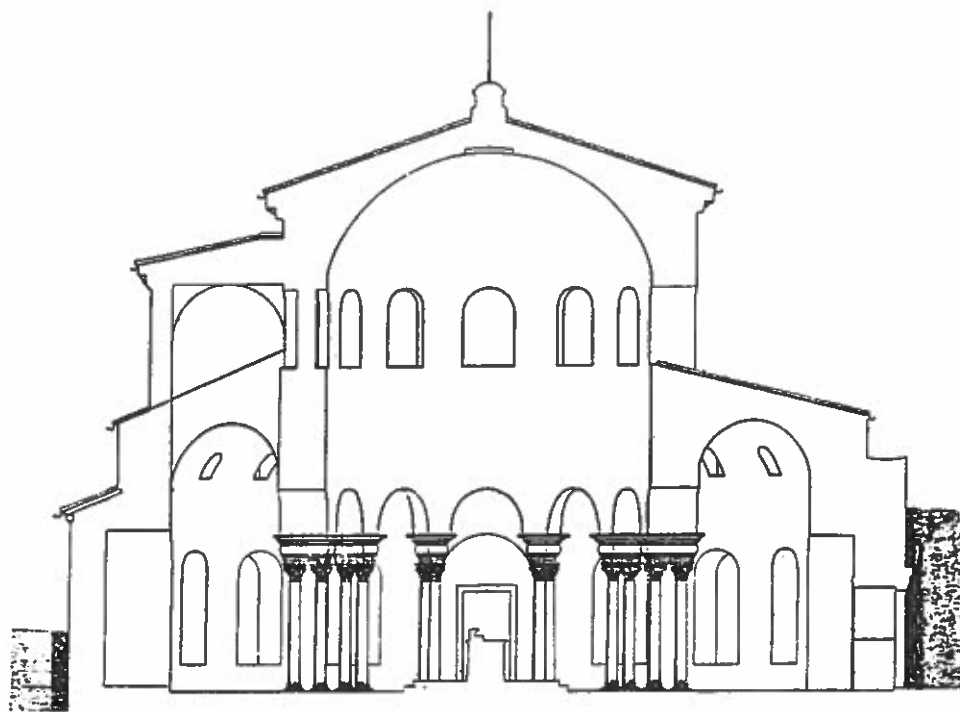

Fig. 3.35 Via Nomentana, S. Costanza. Section. After Donati, *Profilo a Roma*.

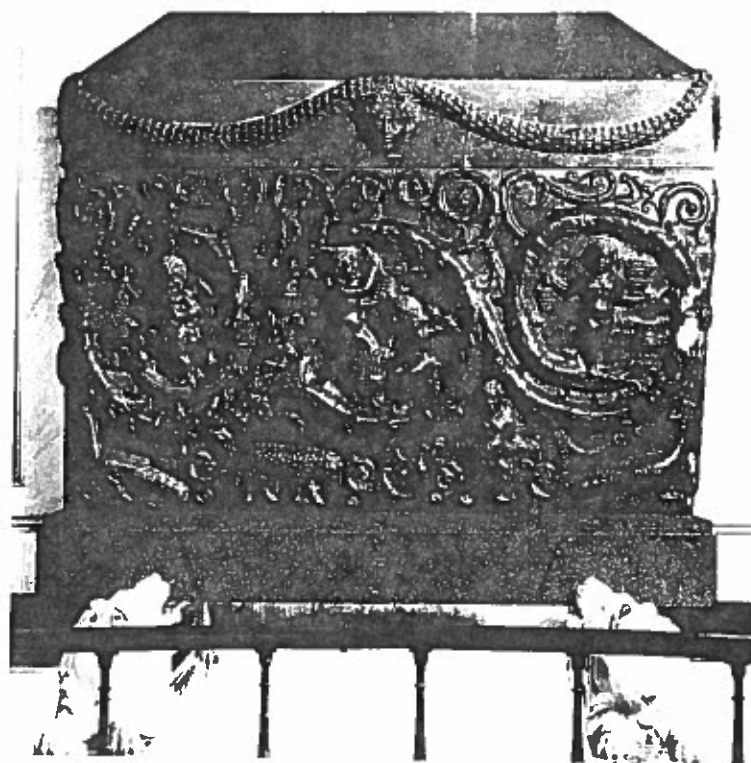

Fig. 3.36 Sarcophagus of Constantia or Helena. Vatican Museum. Photo Como, DAI Rome, Inst. Neg. 63.2342. Copyright Deutsches Archäologisches Institut.

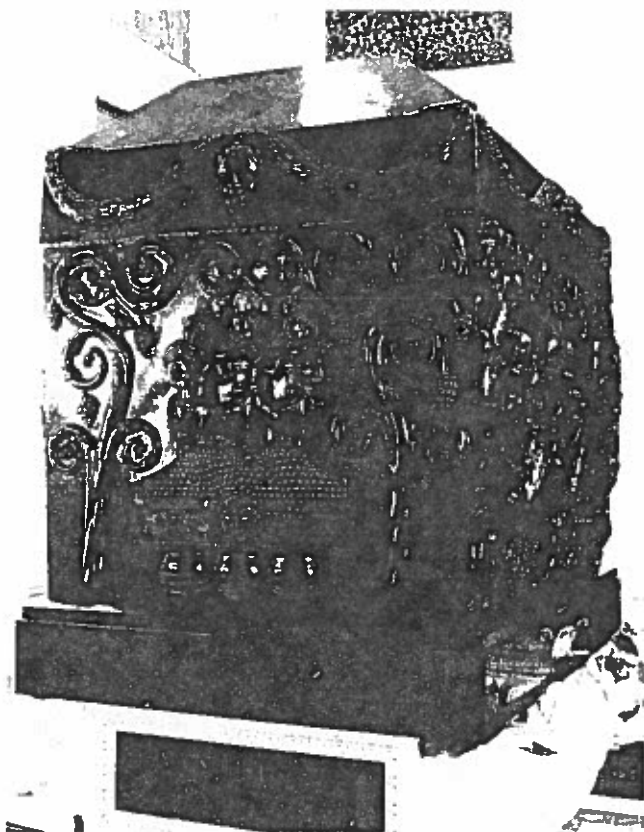

Fig. 3.37 Sarcophagus of Constantina or Helena. Photo Como, DAI Rome, Inst. Neg. 63.2343. Copyright Deutsches Archäologisches Institut.

I—geometric designs (fig. 3.38)

II, XI—lozenges and stars (fig. 3.39)

III, X—cupids, winged female figures, birds in an intertwining frame pattern (fig. 3.40)

IV, IX—vintage (fig. 3.41)

V, VIII—circles with floral and figurative designs (fig. 3.42)

VI, VI—birds, boughs, and greenery, randomly arranged vessels, doves perched on bowl (fig. 3.43).

These mosaics have all the complexity and clarity of high quality design and are consistent with the long traditions of Roman mosaic and stucco work.<sup>108</sup> Only two of the panels have narrative elements, and these are the grape harvesting scenes that appear on the sides of the IV and IX. Most of the surface of these panels is occupied with a vine arbor filled with small figures. At the center of each there is a bust.<sup>109</sup> The total effect, however, is one of the most glorious to be had from any surviving Roman building, a carpeting overhead, fresh, bright, and skillfully made—and traditionally and thoroughly pagan. The design of the mosaic which

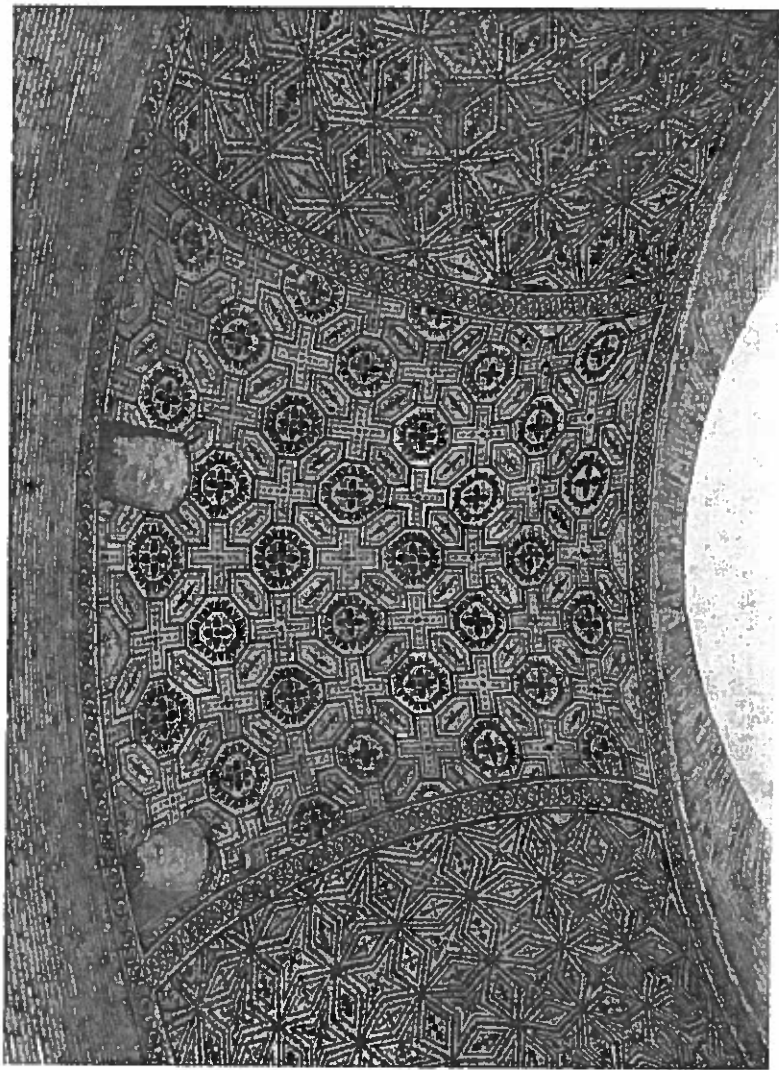

Fig. 3.38 Via Nomentana, S. Costanza. Vault mosaics. Photo Bartl, DAI Rome, Inst. Neg. 57.1257. Copyright Deutsches Archäologisches Institut.

originally occupied the center of the floor was recorded by Pier Sante Bartoli in the seventeenth century.<sup>110</sup> Its subject is a silenus on his donkey preceded by a satyriscus and surrounded by vines, altars, a pipe, and shepherd's crook.

The second point at issue is the name Santa Costanza. Costanza evidently comes from the confusion of the names Constantina and Constantia, the feminine forms of Constantinus and Constans. No member of the imperial family is mentioned directly in connection with the building. The *Liber Pontificalis*, however, says that Constantine acceded to the wishes of his daughter Constantina by erecting a basilica for St. Agnes and a baptistry.<sup>111</sup> The same source adds that both Constantina and her aunt of the same name, sister of the emperor, were baptized

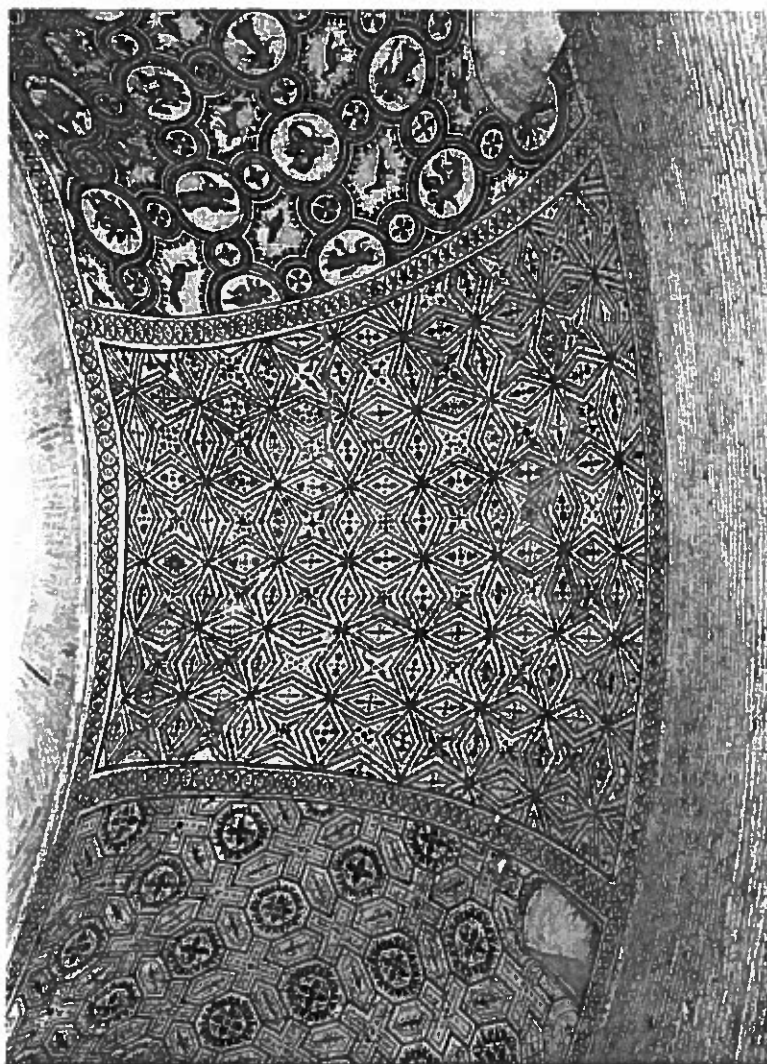

Fig. 3.39 Via Nomentana, S. Costanza. Vault mosaics. Photo Bartl, DAI Rome, Inst. Neg. 57.1249. Copyright Deutsches Archäologisches Institut.

in the baptistry. The role of Constantina in relation to the church of Sant' Agnese is made clear by an acrostic inscription of which a copy survives and which records that Constantina dedicated the church to the virgin martyr.<sup>112</sup> Krautheimer proposed with reason that Constantina's dedication was made after she was widowed in 337.<sup>113</sup>

More than one scholar has interpreted Santa Costanza as the baptistry mentioned in the *Liber Pontificalis*. But the evidence for a font, supposedly found in the nineteenth century, was debated from the time it was announced and has not gained favor since.<sup>114</sup> The building, therefore, is effectively divorced from written tradition. By the ninth century it had acquired the name Santa Costanza and was a church.<sup>115</sup> But if the name is a corruption of Constantina and

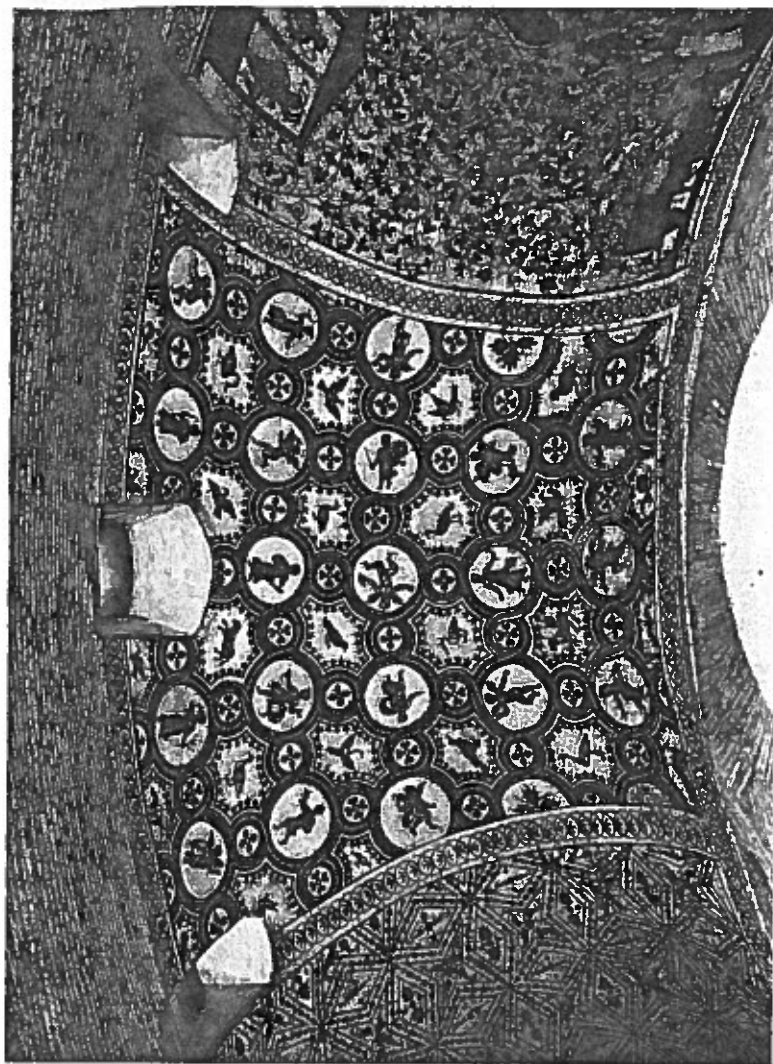

Fig. 3.40 Via Nomentana, S. Costanza. Vault mosaics. Photo Bartl, DAI Rome, Inst. Neg. 57.1253. Copyright Deutsches Archäologisches Institut.

the building was originally a mausoleum, then the connection of the princess with the building cannot be easily dismissed, especially since it is known that Constantina was buried with her sister Helena on the Via Nomentana, presumably in the vicinity of Sant' Agnese.<sup>116</sup>

Artists and scholars of the Renaissance took a marked interest in Santa Costanza. There is a long graphic record of the decoration of the church beginning in the fifteenth century.<sup>117</sup> Among the scholars Marliani, Andrea Fulvio, and Gyraldi all were unanimous in considering Santa Costanza a temple of Bacchus. They saw nothing Christian in a building fitted out with pagan mosaics and a pagan sarcophagus.<sup>118</sup>

At the end of the sixteenth century this view of S. Costanza changes. The change was due to Pompeo Ugonio. A lifelong enthusiast for the history of Roman churches, Ugonio was pro-

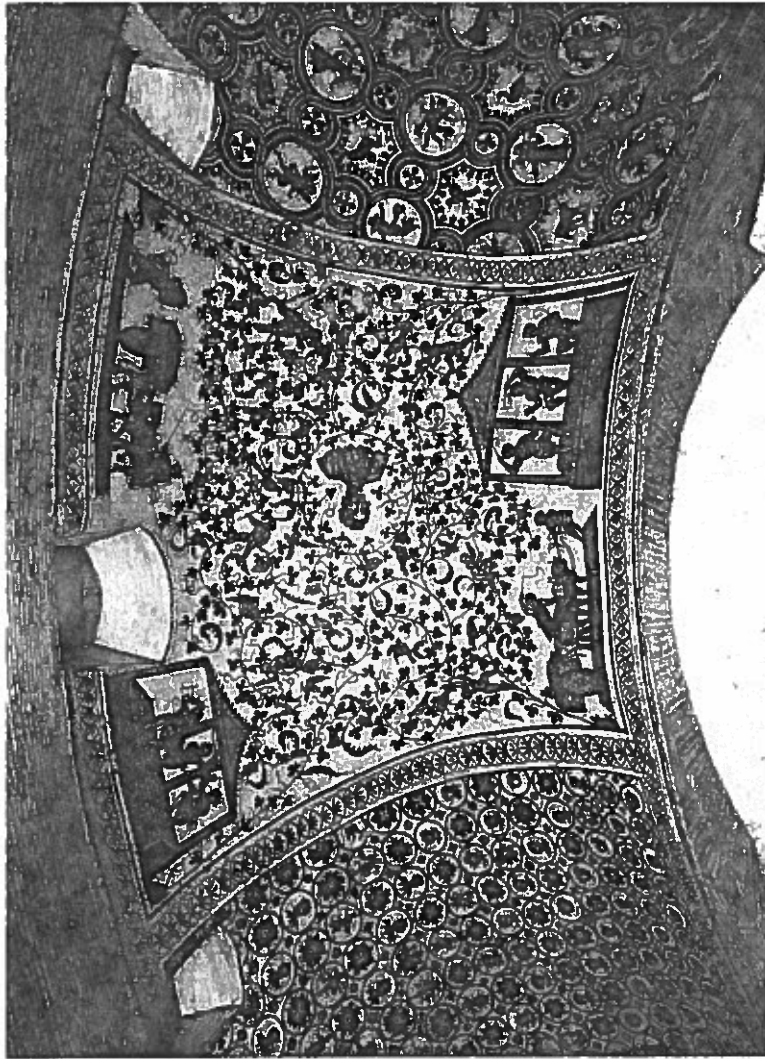

Fig. 3.41 Via Nomentana, S. Costanza. Vault mosaics. Photo Bartl, DAI Rome, Inst. Neg. 57.1250. Copyright Deutsches Archäologisches Institut.

fessor at the Archigimnasio at Rome. He accompanied his pupil Antonio Bosio, father of the modern study of the catacombs, on his first explorations of subterranean Rome.<sup>119</sup> Ugonio owned a vineyard on the Via Nomentana, and, as he tells us in the manuscript describing the first of his visits to the church, on the first of October 1594, during the grape harvest he left his servants and relations at work and betook himself to the church.<sup>120</sup> At Santa Costanza the Counter-Reformation cleric was faced with a church whose pagan character was so notorious that a fraternity of artists from the Netherlands resident in Rome conducted initiations there before the porphyry sarcophagus, which they had baptized the Tomb of Bacchus.<sup>121</sup> Some relatively recent frescoes (including one with Saint Francis) decorated the outer wall of the ambulatory. But looking up above the level of the large windows into the dome, Ugonio saw



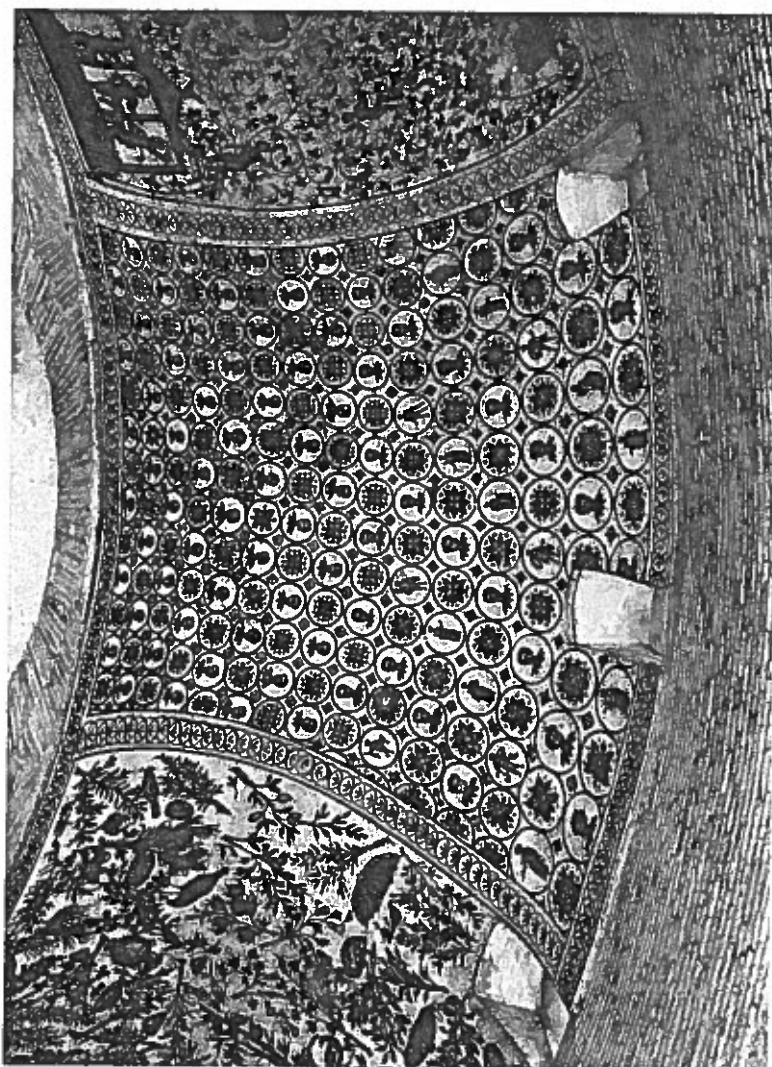

Fig. 3.42 Via Nomentana, S. Costanza. Vault mosaics. Photo Bartl, DAI Rome, Inst. Neg. 57.1251. Copyright Deutsches Archäologisches Institut.

the remains of mosaic decoration which he interpreted as having biblical subjects, Elias, Tobias, Susannah, and Noah. The primary evidence for their identification disappeared in 1620 when a restoration of the church was made by Cardinal Veralli. But Ugonio and the drawings made before the restoration work have served to promote the Christian or at least semi-Christian interpretation of the decoration.<sup>122</sup> Such studies are inevitably made “laboriously but with no conviction,” to quote the opinion of Charles Rufus Morey.<sup>123</sup> Certainly groups of figures—often indistinguishable as to sex—in scenes where there is no clear attribute present can be juggled into biblical story lines.<sup>124</sup> But the effect of these efforts loses further credibility when one considers that the decorative borders of the scenes are adorned with panthers and caryatid maenads. The marine panorama at the base of these scenes, cupids engaged in fishing, is



Fig. 3.43 Via Nomentana, S. Costanza. Vault mosaics. Photo Bartl, DAI Rome, Inst. Neg. 57.1236. Copyright Deutsches Archäologisches Institut.

no less equivocal, being a scene possibly admissible as Christian but thoroughly at home as part of a pagan scheme of decoration.<sup>125</sup>

Two other mosaics are located over the semicircular niches in the ambulatory. In the first Jehovah gives the law to Moses. In the other Christ passes His law to Peter and Paul. On the frame of the niches there were mosaic bands, one of them with stars and the Chi-Rho. This mosaic work is an addition to the original decoration of the building but not a late one. The two mosaic scenes have been compared to the apse mosaic of Christ and the apostles in Santa Pudenziana, and consequently, they may have been added within a century of the erection of the building.<sup>126</sup>

In 1955, Karl Lehmann took up the question of Santa Costanza and argued forcefully that

this was a pagan mausoleum. In doing so he raised the possibility that the mausoleum was connected with Julian, the nephew of Constantine who renounced Christianity publicly when he became emperor in 361.<sup>127</sup> Recent archaeological discoveries have connected Julian even more closely with Santa Costanza. In 1992, David J. Stanley made a small excavation in the antechamber of Santa Costanza. He found, first, that the walls of the antechamber were not bonded into the walls of the large apse-ended basilica. Second, he discovered that below the antechamber there were the remains of a small triconch structure the walls of which did tie into the exterior wall of the basilica (fig. 3.44).<sup>128</sup> The first question that emerges from this important discovery is, What was the lower building, a tomb or the baptistry of the *Liber Pontificalis*? Judging by the disposition of mausolea at other apse-ended basilicas, especially the triconch mausoleum on the south flank of San Lorenzo, the lower building at Santa Costanza appears to be a tomb. One may even hazard the guess, though a guess it must remain, that Constantina was buried here in 354. But when Helena, Julian's newly deceased wife, came to join her what happened? That Julian built Santa Costanza for Helena and her sister Constantina has been argued by G. Mackie.<sup>129</sup> One can second this opinion without, however, believing, as Mackie does, that Julian authorized a half-Christian, half-pagan decorative scheme. It was a tomb flooded with the blessings of Dionysus, not with the grace of Christ, in which Constantina and Helena were finally buried, though still in the place Constantina had chosen beside the apse-ended basilica of the Christians. It appears that both ladies were buried in noble sarcophagi because in addition to the well-known sarcophagus with Dionysiac decoration, a second porphyry sarcophagus from S. Costanza is preserved in the Basilica of S. Pietro in Vaticano.<sup>130</sup>

#### VIA PRAENESTINA

The third apse-ended basilica connected with a mausoleum is found in the complex on the Via Praenestina (Tor dei Schiavi). Here again the mausoleum, the identity of whose builders and occupants remains unknown, as is that of the proprietors of the grand villa which the complex adjoins, has long been a well-known monument of the Roman Campagna. The basilica disappeared, and its plan has been recaptured only by excavation (fig. 3.45).<sup>131</sup>

The mausoleum, however, is a pre-Constantinian structure dating to the period of the tetrarchs. Its walls show no trace of the block and brick construction that becomes common in Constantinian times and already appears in the touches given by Constantine's masons to the Basilica Nova.<sup>132</sup>

The date of the basilica, however, to judge from its brickwork, should lie between the major Constantinian structures and the Theodosian basilica of S. Paolo fuori le Mura.<sup>133</sup> It measures 66 m in length by 28 m in width. It was a covered cemetery. But it is a later follower of the Constantinian coemeteria subteglata, and it was an addition to the architectural landscape of pagan villa and mausoleum of third century and tetrarchic times. There can be no question of the mausoleum and basilica having been planned as a functional unity.

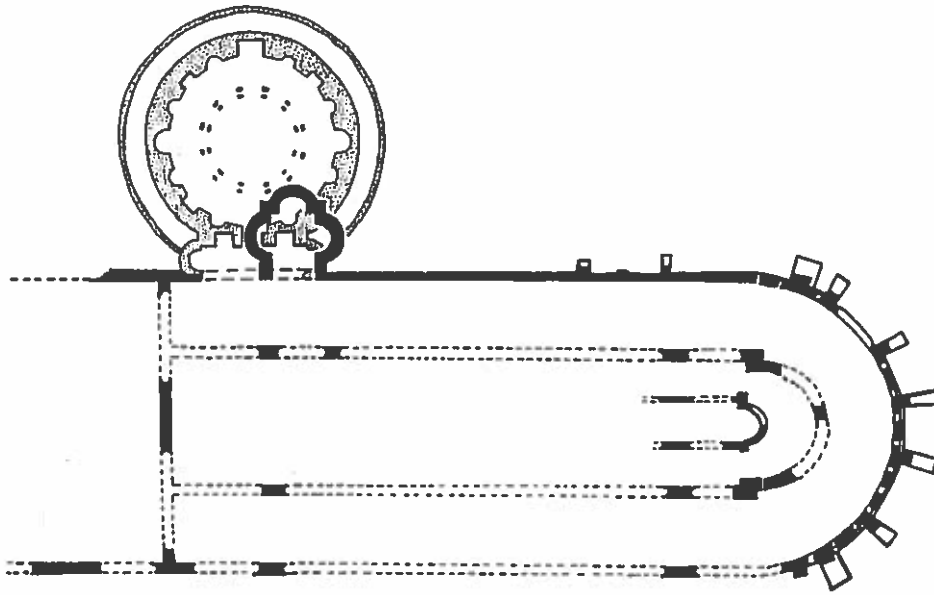

Fig. 3.44 Via Nomentana. Apse-ended basilica, mausoleum, and S. Costanza. After Mackie in *Byzantium* 67.

#### VIA APPIA

Certainly of Constantinian date and a key monument in the history of the cemetery basilica is the Basilica Apostolorum, also known as S. Sebastiano, set in a shady dip of the Via Appia within a short distance of the large catacombs of S. Callisto and of Domitilla (fig. 3.46). The church is screened from the road by the wall of the courtyard before it and almost hides against the rising ground behind. S. Sebastiano is the only Constantinian basilica to survive intact, but the Constantinian structure can be glimpsed only from outside. The interior is masked by the remodeling of the beginning of the seventeenth century. Despite the patronage of Scipio Borghese the work shows a simplicity dictated by economy, except for the handsome paneled ceiling. Excavation and probing through the baroque overlay at various times have made it possible to gain a clear idea of the original basilica.

The ancient name of the church, Basilica Apostolorum, comes from the Apostles Peter and Paul, who were venerated here before the removal of the remains considered to be theirs to the Vatican and the Via Ostiensis. The discussion of the important vestiges of the prebasilica period will be taken up in relation to the Tomb of St. Peter (see chap. 4).

In length the basilica is over 65 m with a width of 30.5 m (fig. 3.47). The aisles are separated from the nave by rows of masonry piers. These form an ellipse in the apse as against the arc of a circle of the exterior wall. Consequently the width of the aisle varies from 5.5 to 5.7 m. A spring within the area now occupied by the basilica was made accessible from there by a flight of stairs. It is now reached by a new stairway from outside. In its original state the nave

may be estimated to have been 58.3 m long and 13.5 m wide, 200 × 45 Roman feet. The aisles and ambulatory had a width of 7 m, not quite 24 Roman feet. The total inner length of 73.4 m approximates 250 Roman feet.

The outer east wall of the Constantinian church has disappeared. But the inner wall between nave and narthex is preserved, although hidden from view. It has openings for three large clearstory windows. In the nave piers carry arches setting off the side aisles. The clearstory had one window above each of nine arcades on each side while in the apse windows and blank spaces alternated above the eight arcades.

S. Sebastiano, like the other apse-ended, extramural basilicas of Rome, was a single great cemetery. The aisles and nave were packed with graves. The inner face of the outer walls, except for the opening to the narthex at the east, was lined with tiers of burial loculi arranged in arcosolium-like embrasures: three tiers above and up to five tiers below the present floor, reaching to a depth of 3 m below the present paving. One may, therefore, envisage the original floor as having been lower than the present paving. Many of the tombs in the floor, moreover, can be dated by their accompanying inscriptions, the earliest, in the eastern part of the south aisle, to 349 and the latest, in the western part of the nave, to 357. Below its floor the church also contained the remains of the portico—in which some 190 graffiti salutations to Sts. Peter and Paul were discovered—known as the *trichia* (portico), and the general area associated with the structure, referred to as the *memoria*. The original basilica seems to have served to keep alive the memory of Peter and Paul on the Via Appia, just as the tomb of St. Peter in the Vatican was memorialized in the Constantinian martyrium. Krautheimer discusses this situation as follows:<sup>134</sup>

To explain these seemingly irreconcilable factors we have to assume that the basilica was built expressly as a burial site and originally had no common level and obviously no pavement. It consisted only of walls and arcades, with roofs covering the area of the memoria complex, the adjoining valley to the west and the higher terraces toward the Via Appia to the east. Within this area the ambulatory and the west portions of the nave and aisles occupied a level corresponding to the lowest tier of loculi and to the stylobate of the nave arcades. On this level, the remains of the *trichia* were left standing over two meters high, while the memoria courtyard may have been filled in level with the stylobate. On the other hand in the east portions of the nave and aisles, presumably from the outset, the level corresponded closely to the present one, which in turn is roughly that of the old terrace east of the memoria complex. One would like to think that the two levels in the nave were linked by stairs. . . . When the tomb of the boy Panigyrius<sup>135</sup> and a number of other graves in its close vicinity were placed on the present level, high above the memoria complex but within its area, burials within the low-lying portions of the graveyard had apparently risen four or five layers.<sup>136</sup>

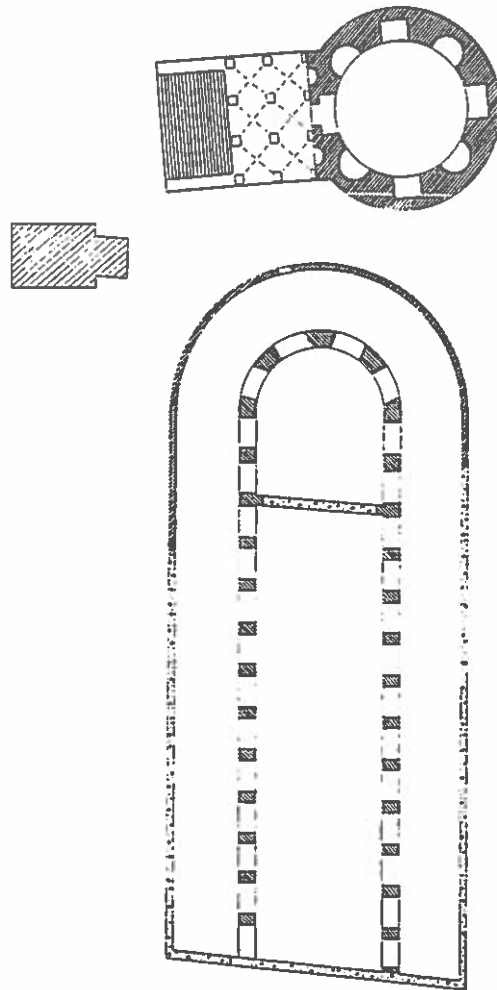

Fig. 3.45 Via Praenestina. Apse-ended basilica.  
After *Felix Temporis Reparatio*.

In any case, in a brief time the original two levels in the nave gave way to one. Since the later datable graves were fitted in among earlier burials it is safe to assume that this had already happened by 340–50. Of course it is equally possible that the lower loculi in the walls and graves under the floor were all occupied at the time of the covering of the church and for this reason there was never a difference in floor level.

The building of the basilica destroyed various funeral monuments. Others were erected, especially along the south side, as soon as the basilica was built. At the end of the fourth century mausolea were also added to the north side of the basilica. Others, detached from the building, were built northward in the direction of the Via delle Sette Chiese.

In all likelihood the crypt of St. Sebastian already existed when the basilica was first built

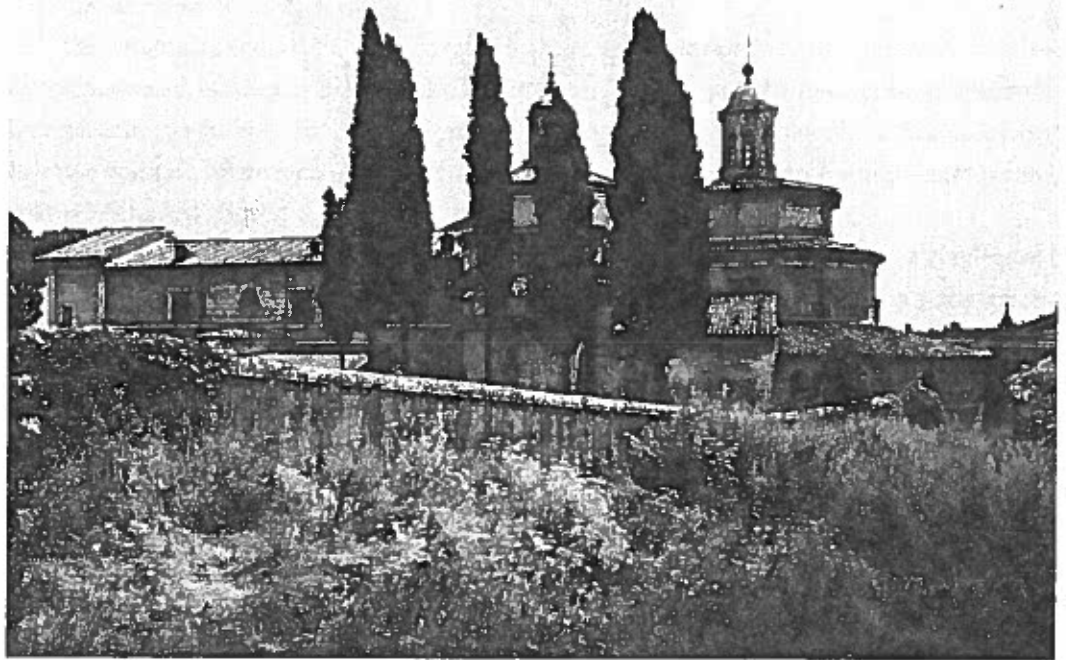

Fig. 3.46 Via Appia. S. Sebastiano. Photo Bartl, DAI Rome, Inst. Neg. 59.1309. Copyright Deutsches Archäologisches Institut.

(fig. 3.48). In the southeast corner of the nave a double stair leads to a crypt, later called the Platonía, which had been formed by widening a catacomb gallery in order to provide for a gathering at the martyr's tomb.

The date of the basilica of S. Sebastiano is uncertain. The church is not mentioned in the list of Constantinian foundations included in the section of the *Liber Pontificalis* devoted to Pope Sylvester or his successors Mark and Julius.<sup>137</sup> But the silence of this document is hardly grounds for excluding a Constantinian date for the building, especially if it was not an imperial project. Largely on the basis of its absence from the *Liber Pontificalis*, scholarly opinion has flirted with the possibility of dating the building even before Constantine. To support this idea there is only one piece of concrete evidence, the use of elliptical window arches in both the basilica and in the Tomb of Romulus, son of Maxentius, whose mausoleum formed part of the grandiose villa of Maxentius directly across the Via Appia from San Sebastiano. Krautheimer connects this detail with the work of a single architect.<sup>138</sup> But surely this detail is just as likely to have been imitated by one group of builders working on S. Sebastiano from the work of a completely different master builder and his men who had worked on the Mausoleum of Maxentius. And even allowing this slender evidence as a valid criterion for dating, there is no way of determining whether San Sebastiano was built in 310, 320, 330, or even later.<sup>139</sup>

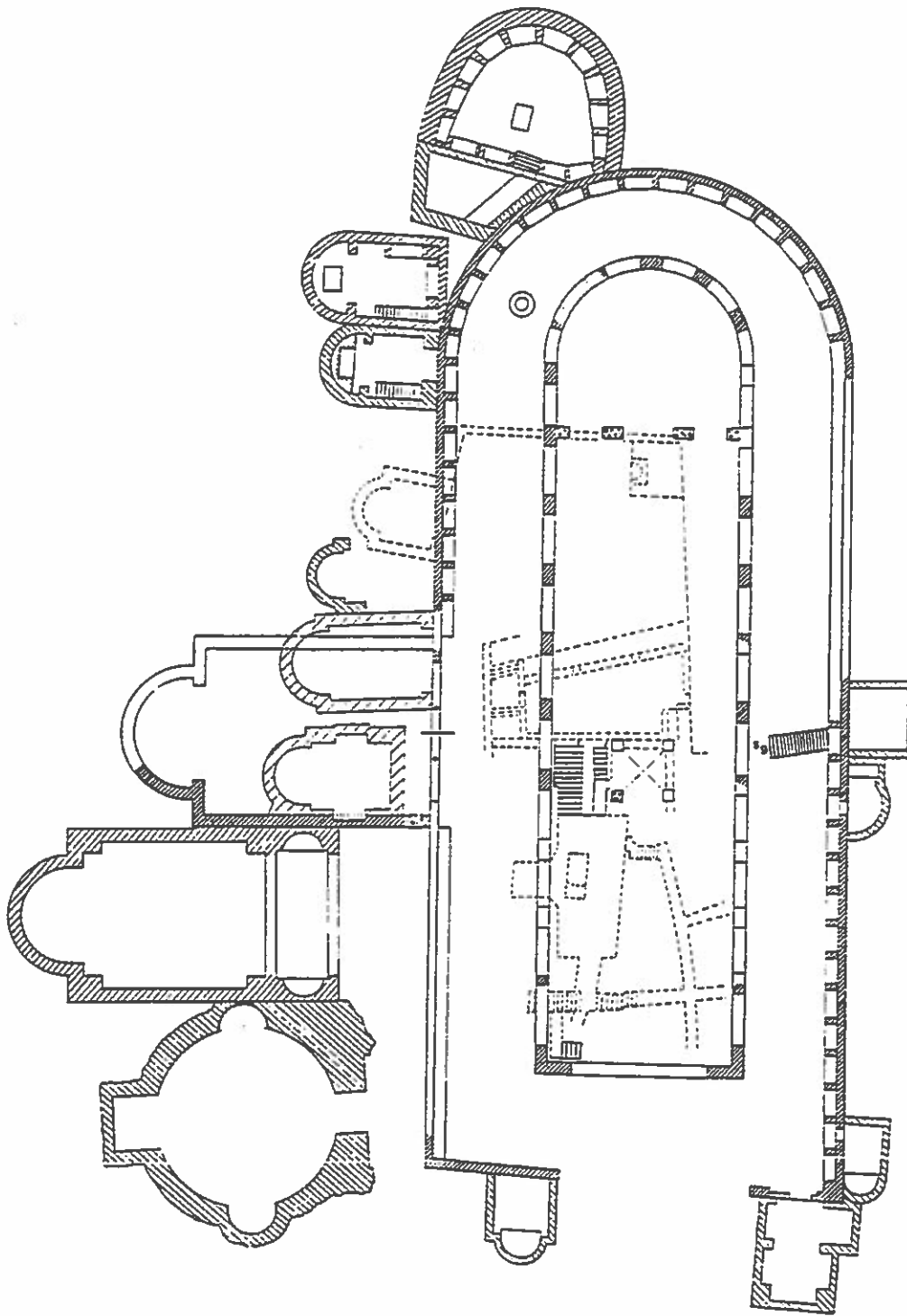

Fig. 3.47 Via Appia. S. Sebastiano. Plan after *Felix Temporis Reperatio*.



## VIA TIBURTINA

The basilica of S. Lorenzo fuori le Mura adjoins Rome's largest cemetery, the Campo Verano, a short distance along the Via Tiburtina, which leaves the city through the gate of the same name on the Esquiline plateau. The Via Tiburtina at this point is a wide thoroughfare, occupied partly by the meeting place of several trolley lines. But the space around the basilica and the cypress trees in the background of the Verano, which occupies the high ground behind and to the sides of the church, create a peaceful setting. San Lorenzo was the only historic monument damaged by the Allied air raid on Rome of July 19, 1943. But apart from shattering the roof, the bombs destroyed only some modern restoration on the interior. This interior, composed of a lower nave and a vast raised presbytery, is one of the most majestic of any surviving Roman churches built before the Renaissance. This is not the Constantinian church. The presbytery was constructed by Pelagius II (579–90), and the nave and porch added by Honorius III (1216–27).

The Constantinian basilica is another of the ghosts of early Christian Rome. It was located immediately south of the existing church, but its remains were brought to light by excavations only in 1950 and 1957 (figs. 3.49, 3.50).<sup>140</sup> This is an area of catacombs, which are found on either side of the Via Tiburtina in the vicinity of the basilica. The catacomb which is around and under the basilica (the Cymiterium Cyriaces of the *Liber Pontificalis*) forms a single unit.<sup>141</sup> It was entered at a point north of the basilica through an opening into the hillside. These catacombs have been little explored except below the present basilica.

The excavations revealed an apse-ended building with ambulatory and nave flanked on each side by an aisle. Its total width is 35.5 m (120 Roman feet). The two aisles and nave, measured along the outer flank of the north wall, are 81.59 m, or 276 Roman feet. The width of the north aisle could be measured and is 8.75 m, or 30 Roman feet. The nave is 17.2 m from center to center of the columns flanking it. This measurement does not translate easily into Roman feet.<sup>142</sup> The total length can be estimated as 333½ Roman feet, or 98.6 m.<sup>143</sup> One column from the interior is partly preserved. It is made of green cipollino marble. Other fragments found outside the building suggest that there were gray cipollino and red granite columns as well. The distance from the center of one column to another (the intercolumniation) can only be estimated at between 3.0 and 3.4 m. A slight indentation of the apse from the line of the nave colonnades is suggested by the observed indentation of the apse where it meets the north outer wall of the building. The arrangement of the façade and entrance is hypothetical. As is to be expected, the interior was one large graveyard.

There are remains of four mausolea against the north wall at the apse end. Only the ends of the walls where they meet the wall of the basilica were excavated. The one farthest to the east was partly built over what seems to be a mausoleum antedating the basilica.

The *Liber Pontificalis* credits Constantine with the erection of a basilica in honor of St. Lawrence.<sup>144</sup> But the bulk of the report there has to do with arrangements made for the mar-

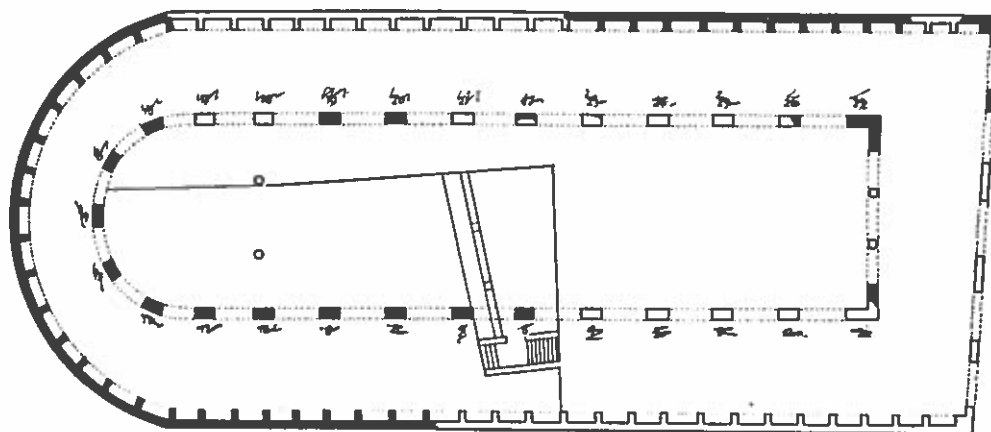

Fig. 3.48 Via Appia. S. Sebastiano. Plan after CBCR.

tyrium of the saint. Before the discovery of the apse-ended basilica this passage appeared hopelessly confused. Now, however, it is clear that the martyrrium was located outside the basilica. The masonry of the basilica fits with a Constantinian date. The basilica was called the *basilica maior* in an epitaph of the late fourth or early fifth century.<sup>145</sup>

#### VIA ARDEATINA

The most recent addition to the group of apse-ended basilicas of the Roman Campagna is the building discovered on the Via Ardeatina in 1990 and published in 1999.<sup>146</sup> Its location is six hundred meters distant from S. Sebastiano and lies in an area rich in catacombs, San Callisto and Domitilla among others. The basilica is possibly that built by Pope Mark in 336, but the identification is hypothetical.<sup>147</sup> The discovery is an achievement of aerial observation. But on this occasion no aircraft or aerial photography were involved. A member of the Salesian house of S. Callisto nearby, looking out an upper window, saw the outline of the basilica in the differential growth pattern of the vegetation in the neighboring field. The following excavation, which, naturally, has been limited in extent, revealed a building 66 m long and 28 m wide. Pilasters created a three-part opening into the presbytery contained within the horseshoe of the ambulatory, as at San Sebastiano. The nave and aisles were packed with tombs, as was a portico behind the apse. In the church the burials were stacked two deep, but along the walls this increased to three or four. One tomb, in the middle of the apse, was a focus of attention. It contained a marble sarcophagus under a masonry arch, and other tombs crowded around it. The deployment of the tombs followed a rational pattern proceeding from the door toward the apse. The aisles and apse were packed to capacity, the nave less so. The interior was apparently decorated with frescoes on a red background and areas of marble (cipollino) revetment. At the rear of the basilica there is a small portico, and tucked in between the portico and apse end there is a mausoleum with cist graves and arcosolium tombs.

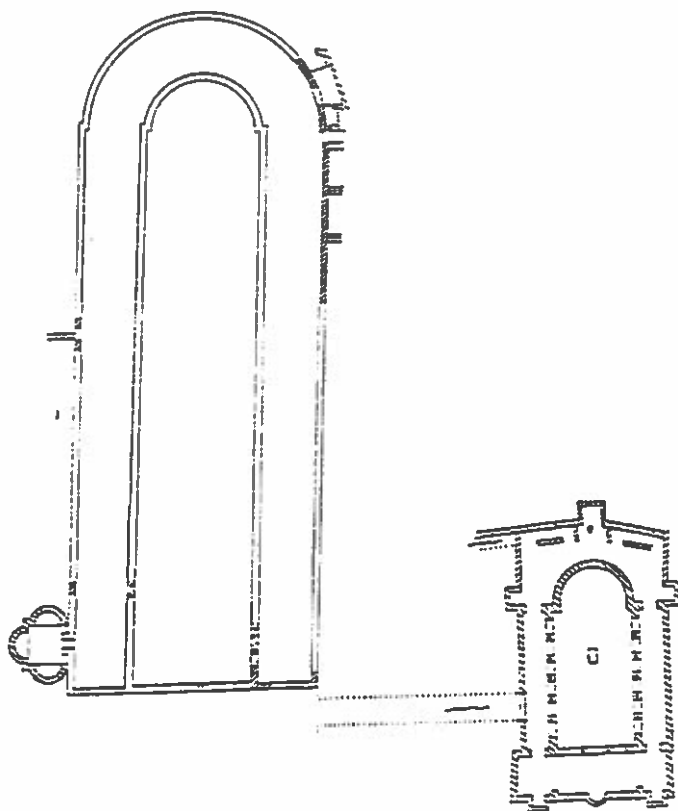

Fig. 3.49 Via Tiburtina, S. Lorenzo. Plan of the apse-ended basilica and later church after *Felix Temporis Reperatio*.

The inscriptions accompanying tombs on the interior of the basilica were level with the floor. The dated epitaphs begin with one of 368. The latest was inscribed in 445. One must remember, however, that only a portion of the interior of the building has been excavated.

#### DISCUSSION

The discovery of the six apse-ended basilicas of the Roman Campagna have led to an intense discussion as to their origin and purpose. These are huge buildings. The largest of them is the length of a football field. The smallest is two-thirds that size. They are also huge covered cemeteries with no permanent clergy attached to them.<sup>148</sup> Except for the basilica of the Via Praenestina, they were built in the neighborhood of Christian catacombs and surface cemeteries. But though close to the resting place of martyrs, they were not usually built over a martyr's grave, and only one has what may be a martyr's grave as a focus of its plan.<sup>149</sup> They represent a spectacular but transient phase of Christian architecture. They were all built within two generations of the beginning of Constantine's rule.

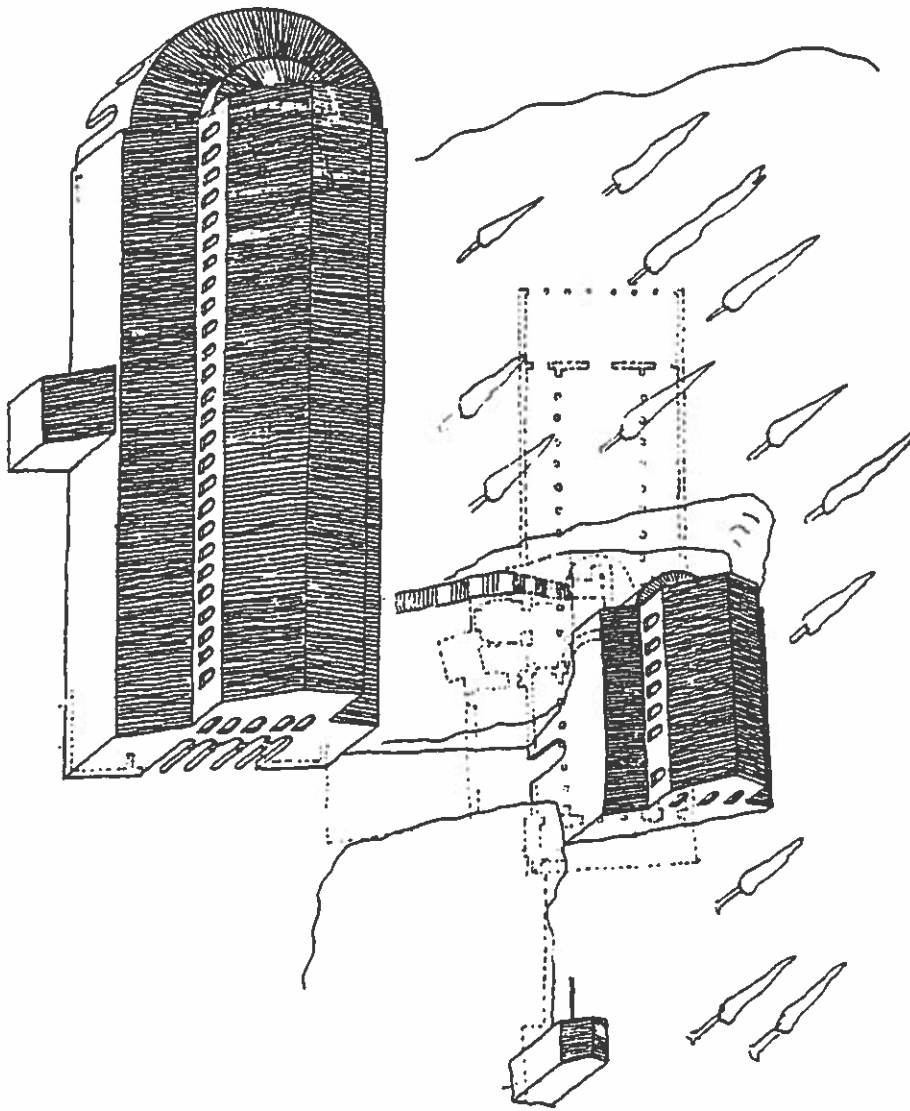

Fig. 3.50 Via Tiburtina. S. Lorenzo. Reconstruction of apse-ended basilica and later church after *CBCR*.

In 1960, Krautheimer tentatively considered (but did not accept) the idea that the apse-ended church could have been derived from the Roman circus.<sup>150</sup> It would thus mirror the comparison made by Tertullian between the race in the circus and the Christian life.<sup>151</sup> More recently confirmation of this suggestion has been found in the oddly canted façades or entrances of the basilicas of the Via Labicana, of San Sebastiano, and of the Via Praenestina. This feature of the three basilicas reproduces, it is held, the angulation of the starting gates of the Roman circus.<sup>152</sup> These observations have led to the formulation of a theory whereby the mausoleum and circus basilica are a continuation of the combination of circus and mausoleum represented

in the Villa of Maxentius on the Via Appia, with all the overtones of heroization implicit in this complex.<sup>153</sup>

As J. B. Ward-Perkins noted, however, the Christian discovery of symbolic values in architecture is a phenomenon of the end of the fourth century.<sup>154</sup> And as far as the starting gates of the circus are concerned, as many of the apse-ended basilicas of the Roman Campagna fail to show evidence of this characteristic as have it. In the case of the Via Labicana, as discussed above, it arises from the fact that the execution of the building project utilized preexisting walls. So only two basilicas, if those, would in any way conform to this pattern. Furthermore, who would have been aware of such a deviation from the symmetry of the entrance to any of the basilicas? The same may be said of the circus apse. Viewing the interior of the basilica with a line of columns or pillars on each side of the nave and the same screening the far end of the building, who would have thought of a circus, especially under the roof of a basilica? The same visual interference of the columns or pillars should make one cautious about any comparison with secular basilicas.<sup>155</sup> Krautheimer's words of caution concerning such speculations are well worth repeating: "Archaeologists, accustomed to looking at plans, have fallen time and again into the trap of such pseudo-resemblances."<sup>156</sup>

The apse-ended basilica of the Via Labicana complex has a good claim to be the earliest of these buildings. As we have already seen, San Sebastiano, though frequently dated early, has no certain chronology. And none of the other basilicas of this class has a claim to be older than the building on the Via Labicana.

As emphasized already in the discussion of the basilica of the Via Labicana it was only one part of a funeral complex that included both mausoleum and basilica. The two were entered from the same door in the south portico. They were inseparably united. The question is, therefore, Why did Constantine and his architects unite a basilica with the mausoleum? and why did they give it its unusual form? The basilica extended burial within the walls of the imperial funeral structure to individuals not of the imperial family. This is not an act to be expected from a pagan. It is an act of Christian charity. As he opened his purse to the poor, orphan children, and women in distress, Constantine opened his door to his Christian brothers and sisters in a way unknown to the pagan, for whom the tomb and the household were inseparable.<sup>157</sup> He housed them in the tomb complex intended for himself and occupied by his mother. He was not deaf to the words, "Thou shalt not turn away from him that is in need, but shalt share with thy brother in all things, and shalt not say that things are thine own; for if thou art partners in what is immortal, how much more in what is mortal?"<sup>158</sup> Perhaps even at this time the pontifex maximus was contemplating the Christian road to salvation.

What was this apse-ended basilica but an amplified mausoleum? A domed building can only be made so large. To exceed what can be covered by a dome it would only be natural to open one side and extend it, thus making a nave and an apse. This kind of architectural invention seems to me far more likely as an explanation of the genesis of the complex of mausoleum and basilica than any symbolic gesture to pagan architecture or pagan thought.

Thus, in my opinion, the apse-ended plan has nothing to do with the circus. It is not a copy of any Roman secular basilica. Neither is it a reminiscence of circus gardens, and far less a partial recreation of the ambulatories of pagan circular tombs or adaptation of the combination of circus and mausoleum. Rather, it was developed as an essential part of the imperial mausoleum on the Via Labicana and was then imitated by other coemeteria subteglata. The type was short-lived, but it was revolutionary.

### *The Catacombs*

In the past the vast underground burial places of the early Christians of Rome have seemed almost synonymous with the early Christians themselves. There are catacombs in every direction along the highways radiating from the city. Underground, their corridors extend for miles in narrow darkness, faintly illuminated from time to time by a light shaft open to the sky above. The galleries of one level lie above those of another below it. Their world today is full of the same gloom that set St. Jerome's teeth on edge when he descended into the catacombs in the fourth century.<sup>159</sup>

Along the main corridors simple burial recesses cut into the side walls (the *loculi*) are stacked five, six, ten high. The small rooms (the *cryptae* or *cubicula*) opening off the corridors can be single chambers or part of a multichambered family tomb belonging to a long pre-Christian tradition of such underground burial suites in the Mediterranean. It is in these tomb suites that fresco decoration is most often found. Occasionally a wider space has been created, generally to form a chapel at the tomb of a martyr. Following the Constantinian age semi-subterranean basilicas were built for the same purpose.

The lore of the catacombs has been infused with fantasy: that Christians used them as refuges during the persecutions; that their church services were conducted in the passages of the catacombs; and that the catacombs themselves were as old as the Christian community in the city.

The catacombs, rather, testify to the consolidation of the Christian position in Rome and to the Christians' growing membership at the end of the second century. The Christians felt a responsibility to insure that all the brothers and sisters, no matter how poor, escaped the fate that awaited the indigent pagan and slave, whose remains were consigned to open refuse pits.<sup>160</sup> We hear of the Christians' sense of obligation in the third century from Tertullian and Hippolytus.

The African bishop puts the Christians' responsibilities succinctly:

A moderate donation on a certain day of the month, as and how the common fund wishes it and if it can arrange it, so it appoints. For no one is forced but makes a contribution spontaneously. For [our funds] are not wasted on banquets and drink and eating houses but are used to feed and bury the poor, to care for boys and girls and such of these that are orphaned, for old servants and the victims of shipwreck

and those condemned to the mines or imprisoned on islands or in confinement, so long as they are imprisoned for their faith and they acknowledged it openly.<sup>161</sup>

And Hippolytus makes the arrangements at Rome in the mid-third century quite clear: "Let there be no heavy charge for burying people in the cemetery for it is for all the poor; except they shall pay the hire of a workman to him who digs and the price of the tiles. And the bishop shall provide for the watchman there who takes care of it from what they offer at the assemblies, so that there be no charge to those who come to the place."<sup>162</sup> Finally to quote Lactantius: "That last and greatest office of piety is burial for foreigners and the poor."<sup>163</sup>

Faced with the need to bury ever more Christians, the community was also faced with the problem of finding space for the purpose. Tunneling below ground was more economical than finding large areas above ground for cemeteries.<sup>164</sup> At the same time the Jews of Rome were adopting the same expedient for their cemeteries.<sup>165</sup>

There was at least one Christian catacomb by the beginning of the third century, when Callixtus was put in charge of it by Pope Zephyrinus.<sup>166</sup> This was surely the complex on the Via Appia that bears Callixtus's name to this day. Like many of the other catacombs, the complex of the Via Appia was developed where a quarry for pozzolana stone had been located. This provided the initial galleries for the purpose. Elsewhere sandstone deposits were also exploited. Preexisting hypogea could be enlarged, and corridors extended from them. And in other circumstances preexisting cisterns and water channels were pressed into service, such as those used in the area of the catacombs on the Via Labicana (SS. Marcellino e Pietro) and at the Catacomb of Priscilla. Callixtus's appointment and Hippolytus's statement make it clear that already in his day the bishop was the controlling authority.

The excavation of the catacombs was carried out by a specialized corps of workmen, the *fossores*. Picturesque images of these catacomb excavators armed with their picks and working by the light of a lamp hung on a movable hook survive in the catacombs.<sup>167</sup> It appears that in the expansion of the catacombs in the fourth century the *fossores* became entrepreneurs, selling loculi directly to their clients, but that papal control was subsequently reestablished.<sup>168</sup>

The planning of the original sections of the catacombs, such as Area I of S. Callisto, shows that the corps of the *fossores* was directed by full-fledged architects. The plan of this catacomb and others like it was developed from straight major galleries with secondary galleries between them (the so-called fish skeleton plan).<sup>169</sup> Subsequently, there was introduced the system of a long major gallery with secondary galleries crossing, such the lower level of S. Priscilla.<sup>170</sup> The precision and regularity of such planning are difficult to appreciate in the general plan of Roman catacombs, which include the various superimposed levels of galleries and the accumulation of two centuries of activity.<sup>171</sup>

During the third century the catacombs retained an egalitarian character. The martyrs' tombs were not significantly distinguished from those of their brethren. The tombs of the

popes in Area I of San Callisto were also plain loculi. Only Sixtus, also a martyr, was buried in a larger cavity covered by a stone slab (the so-called *mensa* tomb).

With the rapid increase in conversions to Christianity in the years following 312, whole sections of catacombs seem to have been laid out, the catacomb of Praetextatus, of Domitilla, of S. Ermete, the catacomb of the Giordani and of Sant' Agnese among others.<sup>172</sup> These galleries were crowded with the simplest kind of loculus burials. It is at the end of the Constantinian age and the decades following, beginning around 330, that the introduction of elaborate family tombs is seen. The apse-ended basilicas also exercised a magnetic effect. On the Via Labicana (SS. Marcellino e Pietro), where it is estimated that some eight thousand tombs were added to the catacomb after 312, the area of expansion is below and around the basilica.<sup>173</sup> The same was true at the catacombs of Sant' Agnese, which developed under the new semisubterranean basilica located to the east of the basilica and mausoleum of S. Costanza, and at S. Sebastiano, where stairs led down to the enlarged catacombs from the church. The same development is also noticeable at S. Callisto.

Pagans felt the same pressures of finding space as the Christians. They too went underground in the third century. Such family hypogea were often enlarged into catacombs and today stand at the heart of the vast Christian networks. One such is the Hypogeum of the Flavii, quite possibly of pagan origin, in the Catacomb of Domitilla.<sup>174</sup> One of the most richly decorated hypogea, that of the Via Latina (Via Dino Compagni), also shows a clear tension between pagan and Christian decoration. This complex of six clusters of chambers was certainly in use in the Constantinian period. Its first phase may be earlier. It was used over a long period of time, and elements of its decoration have been dated into the fifth century.<sup>175</sup>

Chronology, in fact, is a weak point in our knowledge of the catacombs. It is secure only when there is epigraphical evidence. Despite their general brevity, the tomb inscriptions of the catacombs occasionally include beside the name of the deceased a specific date registered by the names of the consuls of the year. Even when such evidence is lacking, the letter forms of the inscription and its phraseology can be helpful. The occasional finds of coins, especially those set in the mortar in which the tiles closing a loculus were secured, provide a good basis of dating, while lamps, gold glasses, and other material offer a less good one. There are still, however, wide differences of opinion, especially as regards the chronology of the fresco decoration of tombs. One subject of dispute concerns the Constantinian age in particular, since a sizable number of frescoes can be dated before the Peace of the Church.<sup>176</sup> In the opinion of the most recent investigator of the Via Labicana catacombs, which are distinguished for the relatively high number of paintings in their aedicula, the great age of catacomb painting is pre-Constantinian.<sup>177</sup>

The frescoes of the catacombs are difficult to treat as major art. The fundamental purpose in painting those chambers that received decoration was to make a light-colored surface that would reflect the lamplight by which the tombs were visited. The white background is frequently



subdivided by a lattice of lines in red. Elaborate framing motives and architectural details are less common. Only rarely are there successive bands across the walls or ceilings covered with floral decoration. Within the fields thus formed there is figure decoration. These figures are small and isolated, and most often the scenes are simple. The execution is often hasty, and it is all too obvious that economy, as well as the noxious working conditions, encouraged haste. The fundamental repertoire is drawn mainly from the Old Testament, emphasizing episodes that can easily be interpreted as harbingers of resurrection and salvation. So we find numerous scenes of Jonah, of the three Hebrew brothers surviving in the fire, Daniel in the lions' den, the sacrifice of Isaac. Similar scenes from the New Testament were used, for example, the raising of Lazarus and Jesus and the Samaritan woman at the well. The Good Shepherd and his lamb appear frequently, and there is more than one instance of the saints reclining at the refrigerium of paradise. Any suggestion of the Passion is avoided; the emphasis is on the resurrection of the faithful. Naturally, there are atypical subjects, some pagan, such as Medusa or Orpheus, others unusual but easily interpreted, such as the crossing of the Red Sea by the Israelites or an occasional scene showing the occupation of the deceased. One must wait for a later moment in the history of catacomb painting, at the end of the fourth century, to encounter monumental images, for example, the scene of the widow Turtura with saints, the Virgin and Christ Child from Domitilla, or the enthroned Christ with saints from the Catacomb of the SS. Marcellino e Pietro. Much of the more common catacomb painting is more amuletic than monumental. These pictures are strangely reminiscent of the miniature landscapes and isolated figures that appear in panels of Roman wall painting of the Julio-Claudian age. Like them, and like the various isolated figures that decorated Roman walls in other centuries, these images appear to be intended for encouraging whispers at the time of burial and commemoration rather than riveting the attention.

Painting belongs to the wealthier tomb clusters of the catacombs. One must not forget that overwhelmingly the tombs of the catacombs belong to persons who could not afford decoration. The cubicula with paintings are certainly representative of a step up the economic scale from the burials of the loculi. But how far up the ladder are they? They are clearly below the level of the mausolea attached to apse-ended basilicas that arose in the same suburban belt around Rome where the catacombs were located. But one cannot simply set up a downward sequence from imperial mausoleum to smaller mausoleum to cubiculum to loculus because there are the cist graves inside and outside the basilicas that must be taken into consideration. Such cemeteries of surface tombs are common in other parts of the Christian Mediterranean. The densely packed tombs around the basilicas of the Via Labicana and the Via Ardeatina provide the most important documentation of this kind in Rome, and they raise the question of how many other cemeteries *sub divo* have escaped attention because the reluctance of the Christians to put grave goods in the tomb makes them difficult to distinguish unless an inscribed tomb marker is found. Do these burials represent a separate social class? One may doubt that the situation is so simple. In fact the basic grave both above and below may have

belonged to the same stratum of society. A stone sarcophagus, whether in the catacomb or in the aboveground cemetery, is an indicator of superior status, as is the decorated cubiculum below ground. But why some Christians were interred in catacombs and others above ground is a question that is not easy to explain.